











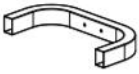
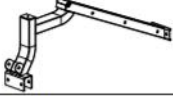







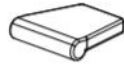





















OWNER'S MANUAL

MPN(s): FIDBENCH

SKU(s): 400636

PARTS & HARDWARE

PARTS LIST				
A U FRAME 1PC 	B MAIN FRAME 1PC 	C REAR BASE 1PC 	D BACKREST SUPPORT 2PCS 	
E SEAT SUPPORT 1PC 	F ADJUSTABLE RACK 2PCS 	G ADJUSTER(OUTER) 1PC 	H ADJUSTER(INNER) 1PC 	
I ADJUSTABLE FOAM FRAME 1PC 	J ANGLE SUPPORT 1PC 	K SEAT PAD 1PC 	L BACKREST 1PC 	
M FOAM 2PCS 	N FOAM PLUG 2PCS 	O RUBBER MAT 1PC 	P ENDCOVER (50-70) 2PCS 	
Q BUMPER 1PC 	R WHEEL 2PCS 	S KNOB (16) 1PC 	T BUSH 4PCS 	
U BUSH (25) 6PCS 	V HANDLE 1PC 	W ENDCAP (25-50) 4PCS 	X ENDCAP (50-70) 2PCS 	
Y PLASTIC SLEEVE 1PC 				

HARDWARE LIST				
1 BOLT(M10*20)  5PCS	2 BOLT(M10*25)  2PCS	3 BOLT(M10*50)  2PCS	4 BOLT(M10*65)  4PCS	5 BOLT(M10*105)  1PC
6 BOLT(M10*16)  1PC	7 BOLT(M12*75)  2PCS	8 BOLT(M12*95)  3PCS	9 BOLT(M12*100)  3PCS	10 BOLT(M12*110)  2PCS
11 BOLT(M12*160)  2PCS	12 WASHER(M10)  17PCS	13 WASHER(M12)  24PCS	14 NYLON NUT(M10)  3PCS	15 NYLON NUT(M12)  12PCS



STEP 1.

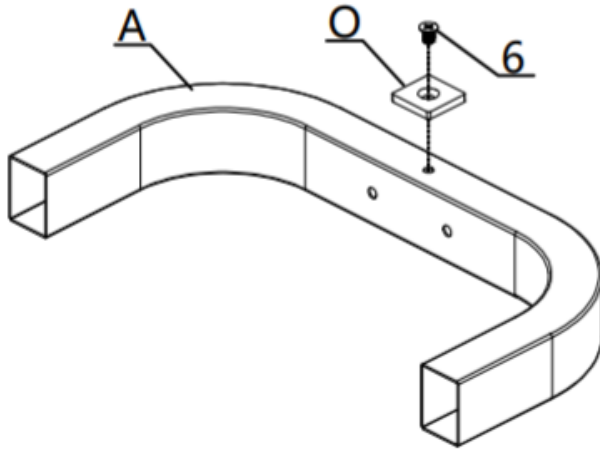

STEP 2.

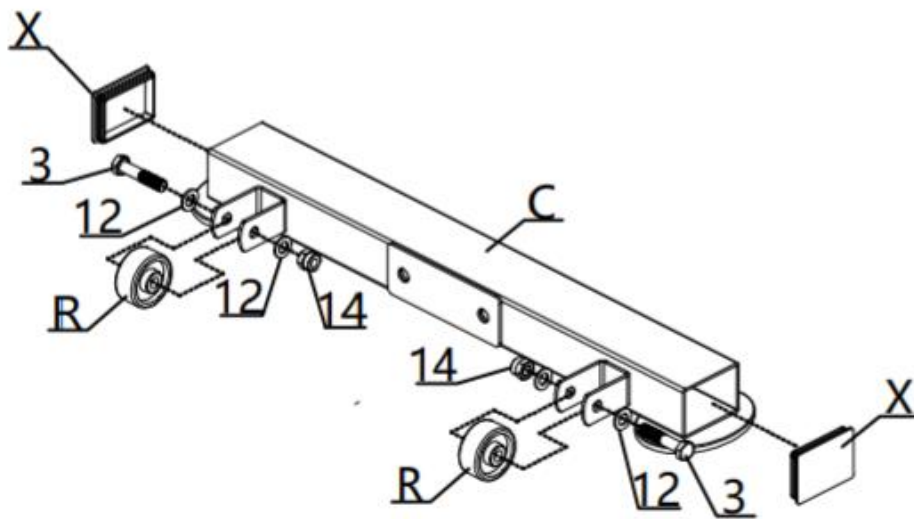

STEP 5.

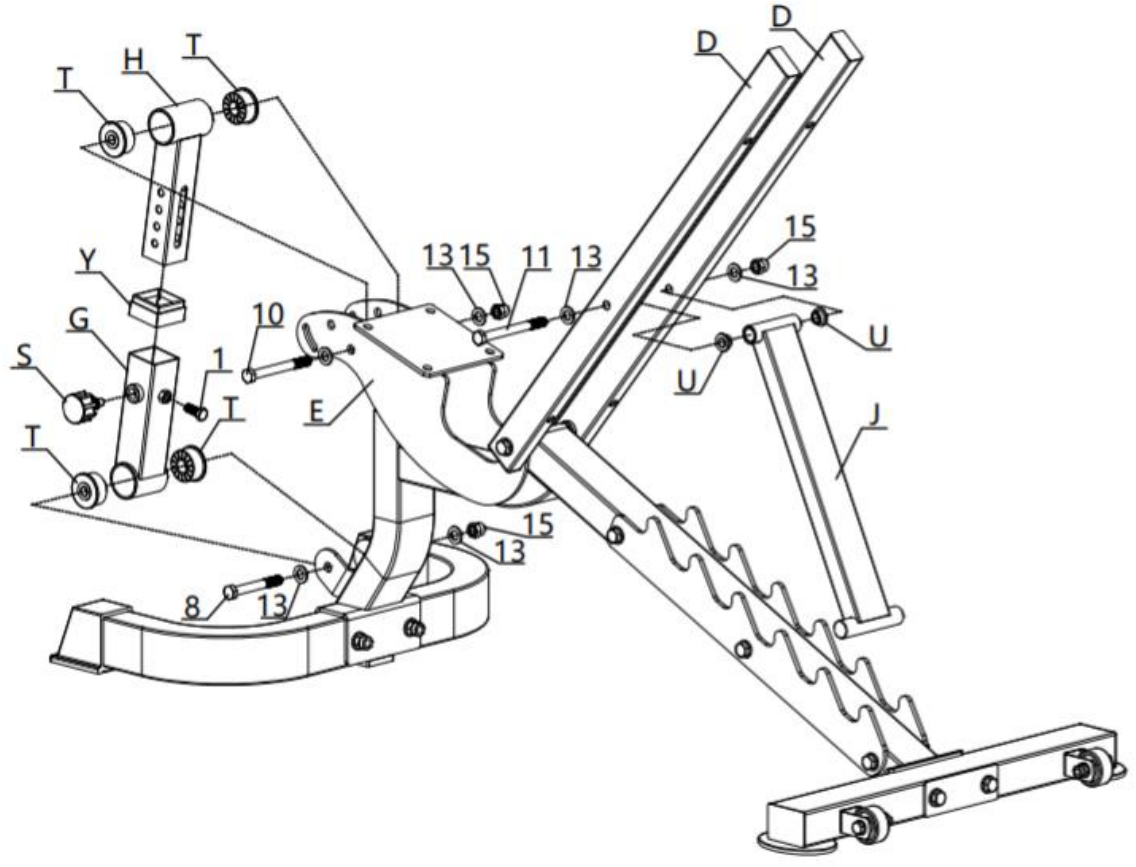

STEP 6.

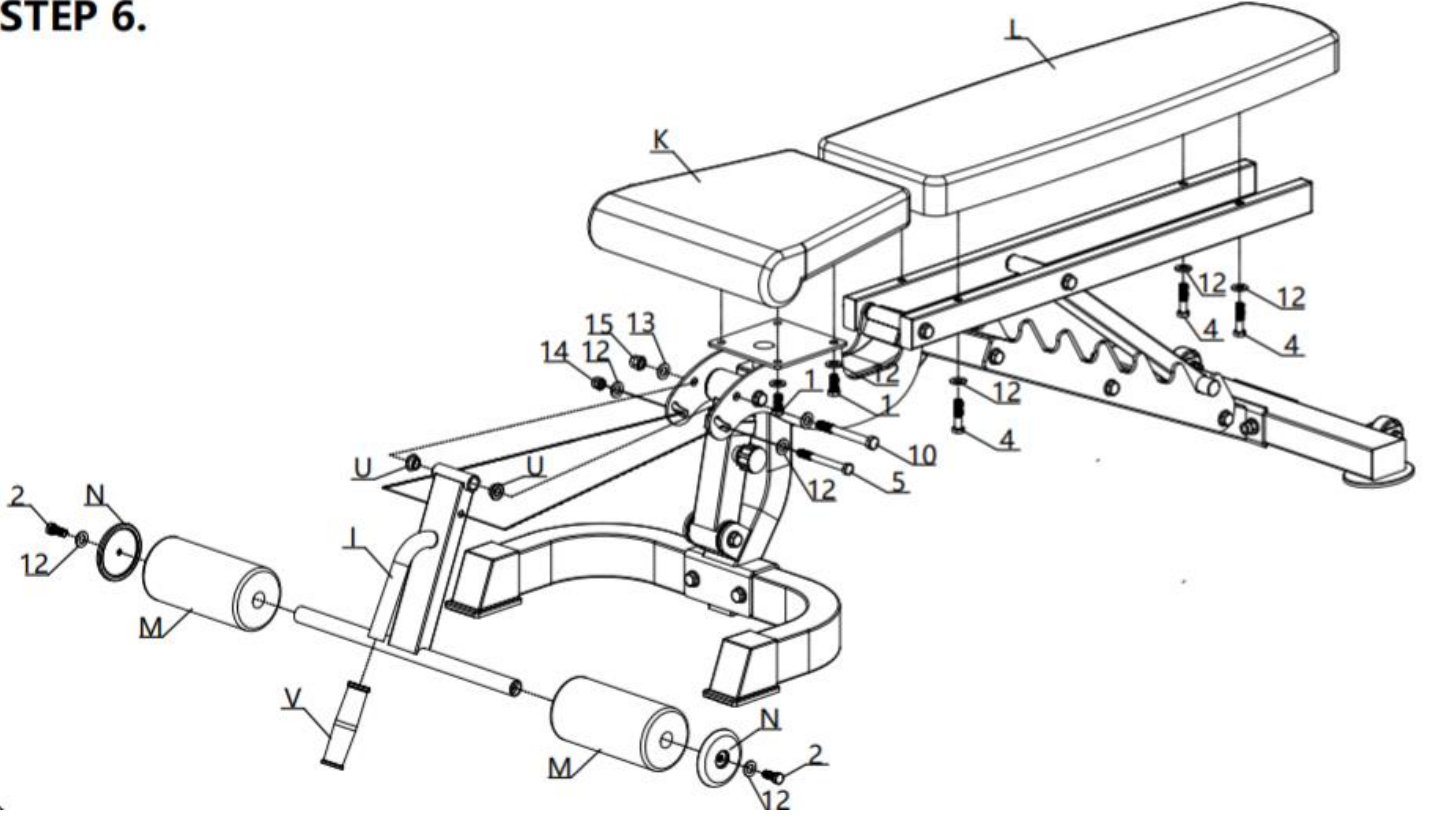



This concludes the FIDBENCH Owner's Manual.

Make sure to tighten all nut-and-bolt combinations before use.

Enjoy!

DISCLAIMER

This equipment must be used with care by capable and competent individuals under supervision, if necessary.

The use of any fitness equipment, including this one, involves the potential risk of injury. You accept and assume full responsibility for any and all injuries, damages (both economic and non-economic), and losses of any type, which may occur, and you fully and forever release and discharge Titan, its insurers, employees, officers, directors, associates, and agents from any and all claims, demands, damages, rights of action, or causes of action, present or future, whether the same be known or unknown, anticipated, or unanticipated, resulting from or arising out of the use of said equipment.

TITAN MAKES NO WARRANTY WHATSOEVER WITH RESPECT TO THE EQUIPMENT, INCLUDING ANY WARRANTY OF MERCHANTABILITY OR WARRANTY OF FITNESS FOR A PARTICULAR PURPOSE, WHETHER EXPRESS OR IMPLIED BY LAW, COURSE OF DEALING, COURSE OF PERFORMANCE, USAGE OF TRADE OR OTHERWISE. BUYER ASSUMES ALL LIABILITY IN USE OF THE EQUIPMENT.

NEED HELP?

CONTACT US FIRST.

1 (800) 605-8241

info@titandistributorsinc.com / www.titan.fitness

Business Hours: Monday–Friday • 8:00 a.m.–5:00 p.m. (CT)

