

TITAN

GREAT OUTDOORS



OWNER'S MANUAL







MPN: QSWNGBEDSS - QSWNGBED_ST

SKUS: 899249

UPC: 840009211522

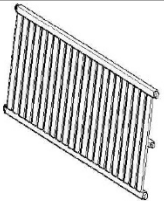
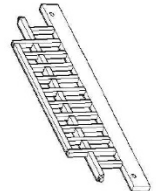
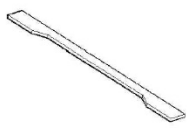
ASSEMBLY INSTRUCTION

MONTANA

A		2 PCS (L&R)
B		2 PCS (L&R)
C		1 PC
D		1 PC
E		1 PC
F		6 PCS
G		10 PCS
H		4 PCS

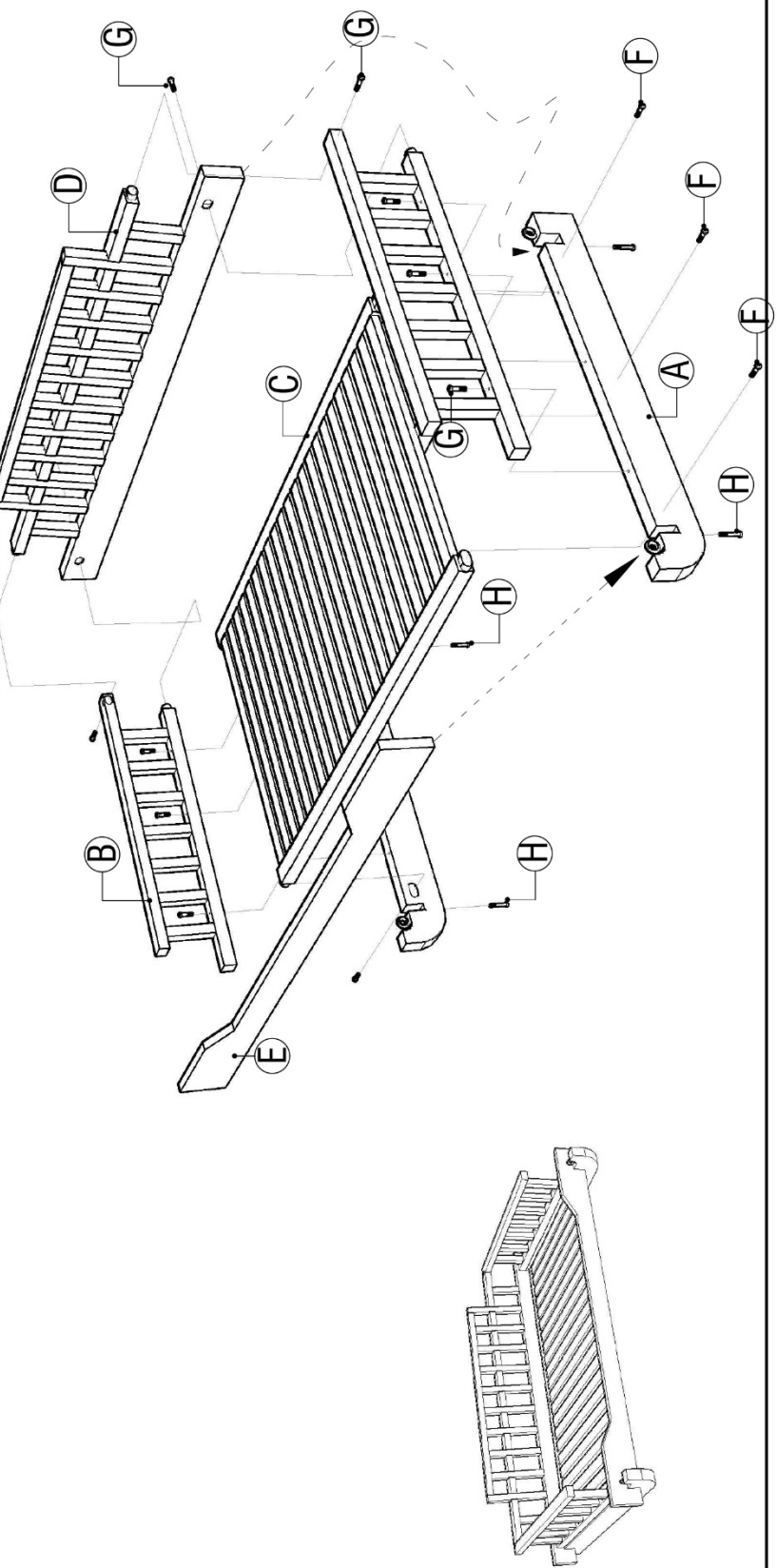

INSTALLATION

STEP 1: Figure out where you want to hang your swing and locate the ceiling joists (studs) that line up closest to the rope hole dimensions of your swing. Most ceiling joists will not line up perfectly with the swing hole points; this is normal. In other words, when the holes on the swing are spaced at 84 inches apart, the closest joists will likely be spaced at 80" or 96" apart. You can either choose to have your ropes angle out, or very slightly in (neither will affect the functionality of the swing). 80" is much closer to 84", so your rope angle won't be noticeable at all.

STEP 2: Pre-drill a hole in the center of the joist (if you have a ceiling or cannot access the joists, please contact a licensed contractor or handyman to install your hooks)

STEP 3: Install your 2-point lag screw eyes to the ceiling.

STEP 4: Loop the chains through the lag screw.

STEP 5: Place the frame of the bed on a 5-gallon bucket to help factor in the ideal height you would like the bed to hang from. Then attached the s-hooks to the bed-base lag screw eye and attach the desired chain link to the other end of the s-hook.

STEP 6: Place all provided cushions and pillows on the base, sit back, and relax!



This concludes the Owner's Manual.

If applicable to your product, make sure to tighten all nut-and-bolt combinations before use.

Enjoy!

DISCLAIMER

This equipment must be used with care by capable and competent individuals under supervision, if necessary.

The use of any equipment, including this one, involves the potential risk of injury. You accept and assume full responsibility for any and all injuries, damages (both economic and non-economic), and losses of any type, which may occur, and you fully and forever release and discharge Titan, its insurers, employees, officers, directors, associates, and agents from any and all claims, demands, damages, rights of action, or causes of action, present or future, whether the same be known or unknown, anticipated, or unanticipated, resulting from or arising out of the use of said equipment.

TITAN MAKES NO WARRANTY WHATSOEVER WITH RESPECT TO THE EQUIPMENT, INCLUDING ANY WARRANTY OF MERCHANTABILITY OR WARRANTY OF FITNESS FOR A PARTICULAR PURPOSE, WHETHER EXPRESS OR IMPLIED BY LAW, COURSE OF DEALING, COURSE OF PERFORMANCE, USAGE OF TRADE OR OTHERWISE. BUYER ASSUMES ALL LIABILITY IN USE OF THE EQUIPMENT.

NEED HELP?

CONTACT US FIRST.

1 (800) 605-8241

info@titandistributorsinc.com / www.titangreatoutdoors.com

Business Hours: Monday–Friday • 8:00 a.m.–5:00 p.m. (CT)

