



WWW.PALLETFORKS.COM

TITAN
ATTACHMENTS



OWNER'S MANUAL

MPN(s): ATVIFRAME - 6ATVIRAKE

SKU(s): 191355

UPC(s): 840009210198

CAUTION

THE FOLLOWING SAFETY PRECAUTIONS SHOULD BE THOROUGHLY UNDERSTOOD BEFORE ATTEMPTING TO BEGIN ASSEMBLING THIS MACHINE

1. Select an area for assembly that is clean and free of any debris which might cause persons working on the assembly to trip.
2. Do not lift heavy parts or assemblies. Use crane, jack, tackle, fork trucks or other mechanical devices.
3. Preview the assembly instructions in your operator's manual before proceeding further.
4. If the assembly instructions call for parts or assemblies to be blocked up, use only blocks material that is good condition and can handle the weight of the assembly to be blocked. Also Ensure that the blocking material is on a clean, dry surface.
5. Never put hands, or any part of body, under blocked up assemblies possible.
6. After completing assembly, thoroughly inspect the machine to be sure that all nuts, bolts, hydraulic fittings, or any other fastened assemblies have been thoroughly tightened.
7. Before operating the machine, thoroughly read the operation section of your operator's manual.
8. Before operating, read the machine section of your operator's manual to be sure that any parts requiring lubrication, such as gearbox, to avoid any possible damage.
9. Before operating equipment – if you have any questions regarding the proper assembly or operation, contact you dealer or representative.



EQUIPMENT SAFETY GUIDELINES

1. Never use alcoholic beverages or drugs which can hinder alertness or coordination while operating this equipment. Consult your doctor about operating this machine while taking prescription medications.
2. Review the safety instructions with all users annually.
3. This equipment is dangerous to children and persons unfamiliar with its operation. The operator should be a responsible adult familiar with farm machinery and trained in this equipment's operations. **Do not allow persons to operate or assemble this unit until they have read this manual and have developed a thorough understanding of the safety precautions and of how works.**
4. Never exceed the limits of a piece of machinery.
5. Do not modify the equipment in any way. Unauthorized modification may impair the function and could affect the life of equipment.

OPERATIONAL SAFETY

1. The use of this equipment is subject to certain hazards which cannot be protected against by mechanical means or product design. All operators of this equipment must read and understand this entire manual, paying particular attention to operating, prior to using. If there is something in this manual you do not understand, ask your supervisor, or your dealer, to explain it to you.
2. Personal protection equipment including hard hat, safety glasses, safety shoes, and gloves are recommended during assembly.
3. Never permit any person other than the operator to ride or board the tractor or implement at any time. **ALLOW NO RIDERS!**
4. A heavy load can cause instability in driving a tractor. Make sure the front or rear of the tractor is properly counter-balanced with weights, always drive slowly-especially around turns. An unstable tractor could steer badly and possibly tip over, causing injury or death.
5. Most accidents occur because of neglect or carelessness. Keep all helpers and bystanders at a safe distance.



MAINTENANCE SAFETY

1. Keep all persons away from operator control area while performing adjustments, service, or maintenance.
2. Periodically tighten all bolts, nuts and screws and check that all cotter pins are properly installed to ensure unit is in a safe condition.
3. Never use your hands to locate a hydraulic leak on attachments. Use a small piece of cardboard or wood.
4. Never replace hex bolts with less than grade five bolts unless otherwise specified. Refer to bolt torque chart for head identification marking.

STORAGE SAFETY

1. Store the unit in an area away from human activity. Do not permit children to play on or around the stored unit.
2. Make sure all parked machines are on a hard, level surface and engage all safety devices.
3. If blocking is used, make sure it is solid and secure before leaving area



PARTS DIAGRAM / EXPLODED VIEW

ATVIFRAME

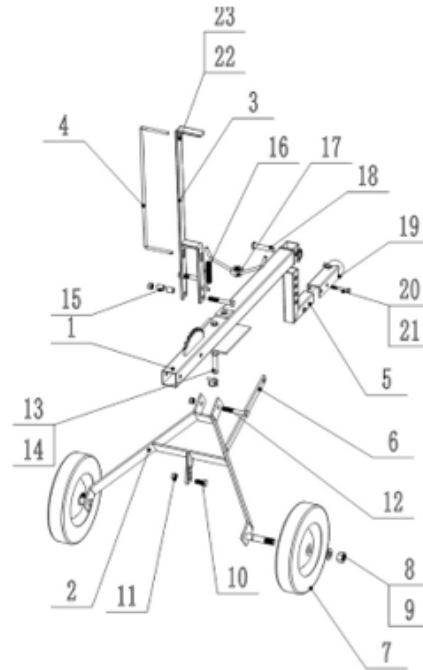

KEY	BOX	DESCRIPTION	QTY
(1)		Main Frame Weld	1
(2)		Wheel Hub	1
(3)		Handle	1
(4)		Position Adjust Handle	1
(5)		Height Adjust Handle	1
(6)		Brace	1
(7)		Wheels	2
(8)		Flat Washer (Φ24)	2
(9)		Bolt (M24)	2
(10)		Bolt (M16*45)	1
(11)		Locked Nut (M16)	4
(12)		Bolt (M16*110)	4
(13)		Pin (Φ19X115)	1
(14)		O Spring Pin	2
(15)		Sleeve	2
(16)		Spring	1
(17)		Nut (M30)	1
(18)		Pin (Φ19X95)	1
(19)		Ball Hitch	1
(20)		Bolt (M12*80)	2
(21)		Nut (M12)	2
(22)		FLAT WASHER (Φ10)	1
(23)		R PIN	1

PARTS DIAGRAM / EXPLODED VIEW (cont.)

ATVIRAKE

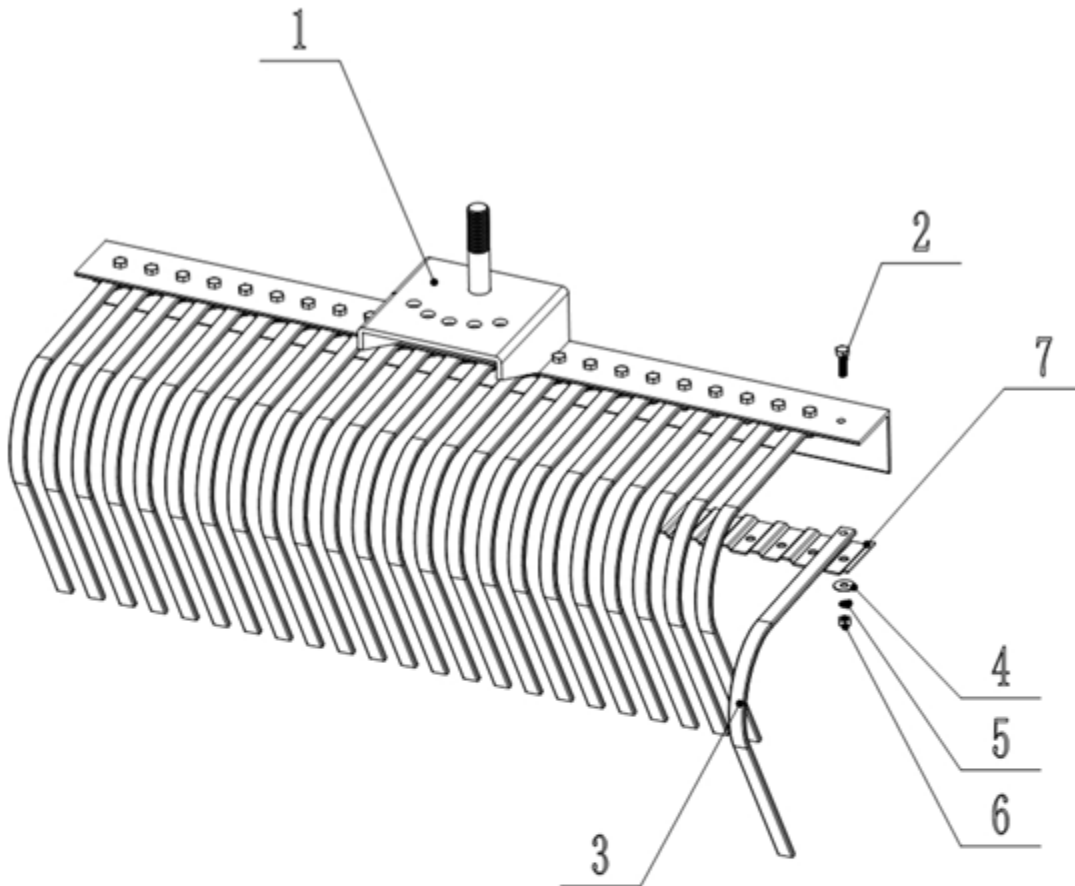

KEY	BOX	DESCRIPTION	QTY
(1)		TINE BAR	1
(2)		BOLT (M10X35)	24/36
(3)		RAKE TINE	24/36
(4)		FLAT WASHER (Φ10)	24/36
(5)		SPRING WASHER (Φ10)	24/36
(6)		NUT (M10)	24/36
(7)		TINE PLATE	4/6

ASSEMBLY INSTRUCTIONS

ATVIFRAME

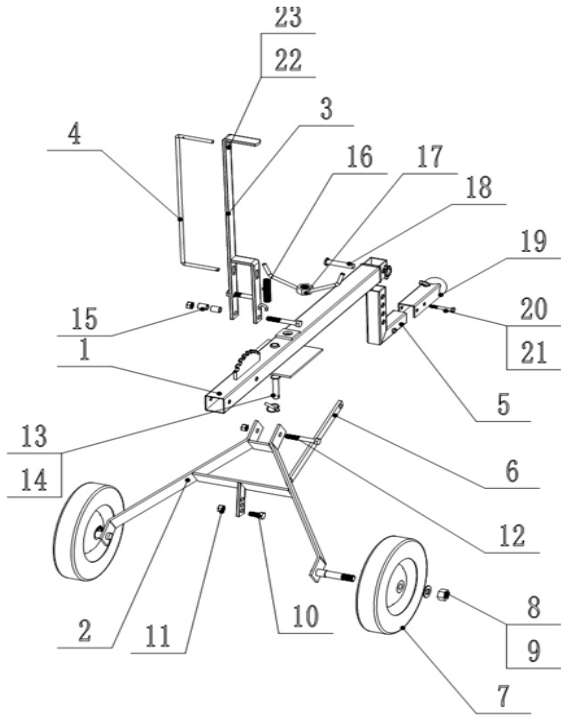

ATVIRAKE

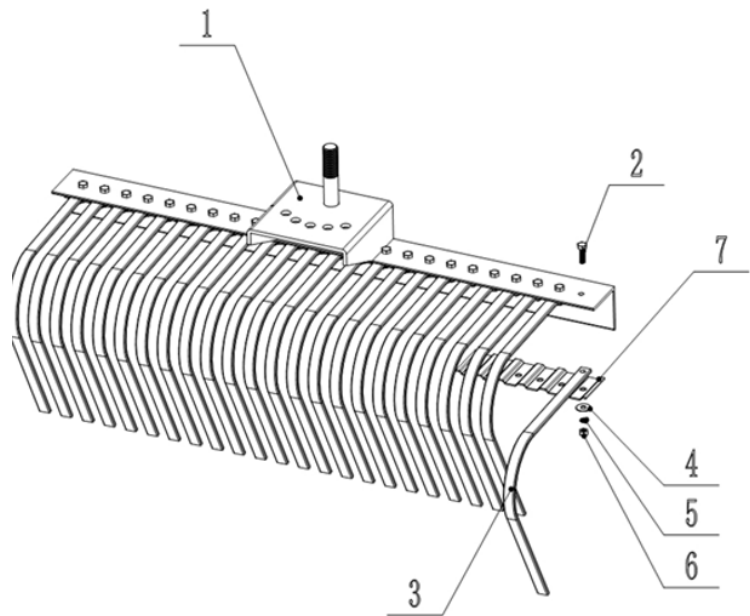



This concludes the ATVIFRAME - 6ATVIRAKE Owner's Manual.

If applicable to your product, make sure to tighten all nut-and-bolt combinations before use.

Enjoy!

DISCLAIMER

This equipment must be used with care by capable and competent individuals under supervision, if necessary.

The use of any equipment, including this one, involves the potential risk of injury. You accept and assume full responsibility for any and all injuries, damages (both economic and non-economic), and losses of any type, which may occur, and you fully and forever release and discharge Titan, its insurers, employees, officers, directors, associates, and agents from any and all claims, demands, damages, rights of action, or causes of action, present or future, whether the same be known or unknown, anticipated, or unanticipated, resulting from or arising out of the use of said equipment.

TITAN MAKES NO WARRANTY WHATSOEVER WITH RESPECT TO THE EQUIPMENT, INCLUDING ANY WARRANTY OF MERCHANTABILITY OR WARRANTY OF FITNESS FOR A PARTICULAR PURPOSE, WHETHER EXPRESS OR IMPLIED BY LAW, COURSE OF DEALING, COURSE OF PERFORMANCE, USAGE OF TRADE OR OTHERWISE. BUYER ASSUMES ALL LIABILITY IN USE OF THE EQUIPMENT.

NEED HELP?

CONTACT US FIRST.

1 (800) 605-8241

info@titandistributorsinc.com / www.palletforks.com

Business Hours: Monday–Friday • 8:00 a.m.–5:00 p.m. (CT)

