

13W ROTISSERIE GRILL

SRG13WS

899982



TITAN
GREAT OUTDOORS

Operator's Manual



Read the Operator's Manual entirely. When you see this symbol, the subsequent instructions and warnings are serious follow without exception. Your life and the lives of others depend on it!

Cover photo may show optional equipment not supplied with standard unit. For an Operator's Manual and Decal Kit in French or Spanish Language, please see your dealer.

PARTS DIAGRAM / EXPLODED VIEW

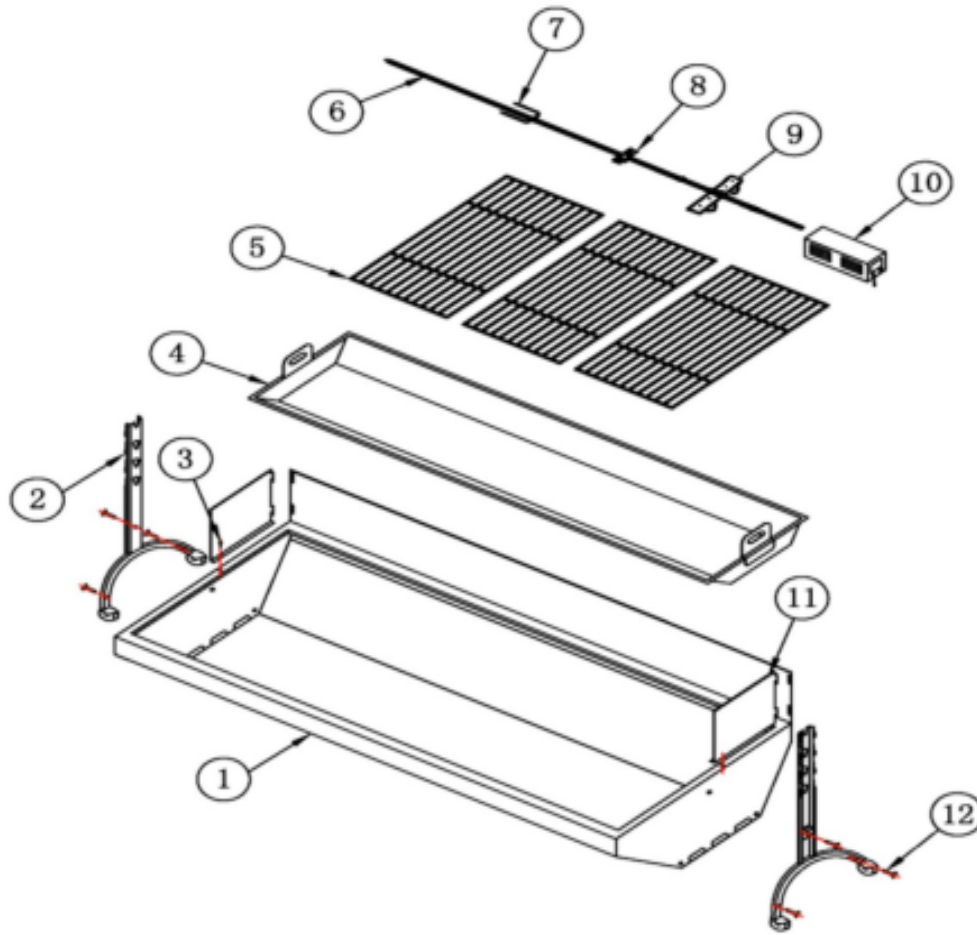

KEY	PART #	DESCRIPTION	QTY
(1)	P899981 - 1	TROUGH	1
(2)	P899981 - 2	LEG	2
(3)	P899981 - 3	SCREW FOR WINDSCREEN	7
(4)	P899981 - 4	CHARCOAL TRAY	1
(5)	P899981 - 5	S/S GRATE	3
(6)	P899981 - 6	SPIT ROD	1
(7)	P899981 - 7	FORK	1
(8)	P899981 - 8	SPINE HOOK	1
(9)	P899981 - 9	FOOT HOOK	1
(10)	P899981 - 10	MOTOR	1
(11)	P899981 - 11	WINDSCREEN PARTS	3
(12)	P899981 - 12	LOCKING CASTER	4

ASSEMBLY INSTRUCTIONS

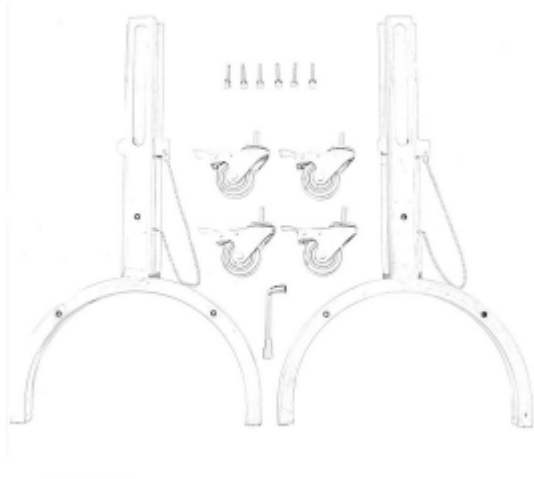

- (1) Trough
- (2) Legs
- (12) Locking casters Included hardware and tool



- Screw locking casters into the bottom of the legs.
- Bolt the legs onto the trough using the provided hardware and tool.



- (4) Charcoal Tray
- (5) Stainless Steel Grates
- (11) Windscreen and included screws

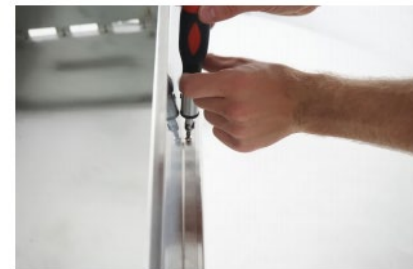

- Set the charcoal tray into the slots inside of the trough.
- Place the stainless-steel grates in place on top of the trough.
- Mount the windscreen on the backside of the trough with the screws on the outer side.

ASSEMBLY INSTRUCTIONS



- (10) Motor
- (6) Spit Rod
- (7) Fork
- (8) Spine Hook
- (9) Foot Hook



- Slide the motor onto the upright of the leg.
- Slide the fork, spine hook, and feet hooks onto the spit rod and turn screws to tighten in place.
- Install the spit rod. Ensure the notch is locked onto the motor and slid all the way back.
- Adjust the spit rod height using removable pins.

PRODUCT DETAILS

FEATURES
HIGH QUALITY STAINLESS STEEL
STRONG 13W MOTOR FOR LARGE ROASTS
HEAVY DUTY SPIT ROD HOLDS ENTIRE ANIMAL FOR ROASTING
HEAVY DUTY SPIT ROD HOLDS ENTIRE ANIMAL FOR ROASTING
SAVES CHARCOAL BY DIRECTING HEAT TO THE MEAT
3 TIER COOKING HEIGHT ADJUSTMENT
WINDSCREEN FOR FASTER AND CLEANER ROAST

TECHNICAL SPECIFICATIONS	
SPIT LENGTH	51-IN.
MOTOR CAPACITY	88 LB.
MOTOR POWER	13W
SPEED	4 RPM
WEIGHT	84 LB.
MATERIAL	STAINLESS STEEL

IMPORTANT SAFETY INFORMATION

IMPORTANT SAFETY INFORMATION

- It is the sole responsibility of the purchaser of Titan Distributors products to instruct all individuals, whether they are the end user or supervising personnel on the proper usage of the equipment.
- Use outdoors only. Read safety information before using this appliance.
- Accessible parts may be very hot. Keep young children and pets away.
- Do not move appliance during use.
- Use caution when handling or transporting this product.
- Metal edges can produce a hazard. Use appropriate gloves when lifting or handling.
- Use protective gloves when handling hot components. Any modifications of the appliance may be dangerous.

ELECTRICAL CAUTION

- If any accessory is used on this appliance that requires an external power source when installed, the accessory must be electrically grounded in accordance with local codes.
- Do not cut or remove the grounding prong from the plug.
- Keep the electrical supply cord away from any heated surface.

PREPARING THE SPIT

- Select the appropriate accessories for holding the cut of meat you will be cooking.
- Try to determine the center of weight for the cut of meat and use this point to insert the spit rod.
- Position the meat in the center of the horizontal length of the spit rod and ensure it is well secured.
- Ensure that the spit supports allow for the rod to be as level as possible.
- Place the spit with the meat into the rod spit supports. Make sure that the motor output is aligned properly with the slot in the rod.
- Ensure that meat is balanced to ensure maximum efficiency of motor.

STARTING CHARCOAL FIRE

- With the spit and meat in place, begin by placing a small mound of lump charcoal, or charcoal briquettes in the bottom and center of the charcoal tray.
- The mounds of charcoal can now be lit using matches and starter fluid. Allow mounds to fully ignite.
- With a heat resistant tool, start to spread the ignited mounds of charcoal outwards from the center of the tray to create an evenly distributed heat source.
- Add additional charcoal over the length of the tray to increase the temperature of the heat source.
- Charcoal level will have to be monitored to maintain desired heat level. Add charcoal as required.

ACKNOWLEDGEMENT OF RISK AND RELEASE OF LIABILITY

The use of any equipment, including this one, involves the potential risk of injury. Apart from any warranty claim that might be presented for a claimed defect in material or workmanship of the product, you accept and assume full responsibility for any and all injuries, damages (both economic and non-economic), and losses of any type, which may occur, and you fully and forever release and discharge Titan, its insurers, employees, officers, directors, associates, and agents from any and all claims, demands, damages, rights of action, or causes of action, present or future, whether the same be known or unknown, anticipated, or unanticipated, resulting from or arising out of the use of said equipment.

This equipment must be used with care by capable and competent individuals under supervision, if necessary.

WARNING



Heavy object. Use lifting aids and proper lifting techniques when moving.



Choking hazard. Small parts – Please exercise caution if small children or pets are present.



Sharp objects may be involved. Use precaution and protection.

TITAN LIMITED WARRANTY: TERMS, EXCLUSIONS AND LIMITATIONS OF REMEDIES

This product comes with a one (1) year limited warranty that can be found at www.titangreatoutdoors.com/warranty.html. Please review the same for all details regarding the Titan Limited Warranty.

THE TITAN LIMITED WARRANTY FOUND AT WWW.TITANGREATOUTDOORS.COM/WARRANTY.HTML IS EXCLUSIVE AND IS IN LIEU OF ALL OTHER WARRANTIES, EXPRESS OR IMPLIED, INCLUDING ANY IMPLIED WARRANTY OF MERCHANTABILITY AND/OR FITNESS FOR A PARTICULAR PURPOSE, EACH OF WHICH IS HEREBY DISCLAIMED.



NEED HELP? CONTACT US FIRST.

1-888-794-1455

info@titangreatoutdoors.com

www.titangreatoutdoors.com

© 2021 Titan Brands