

# GRADE A TEAK MONTANA QUEEN CHAIN PORCH SWING

---

QSWNGBEDSS - QSWNGBED\_ST  
899249









## Operator's Manual

**TITAN**  
GREAT OUTDOORS

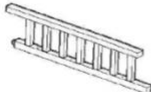

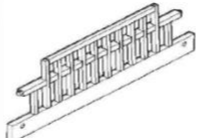
Read the Operator's Manual entirely. When you see this symbol, the subsequent instructions and warnings are serious follow without exception. Your life and the lives of others depend on it!

**PARTS DIAGRAM / EXPLODED VIEW**

A	B	C	D	E	F	G	H
							
2 PCS (L&R)	2 PCS (L&R)	1 PC	1 PC	1 PC	6 PCS	10 PCS	4 PCS

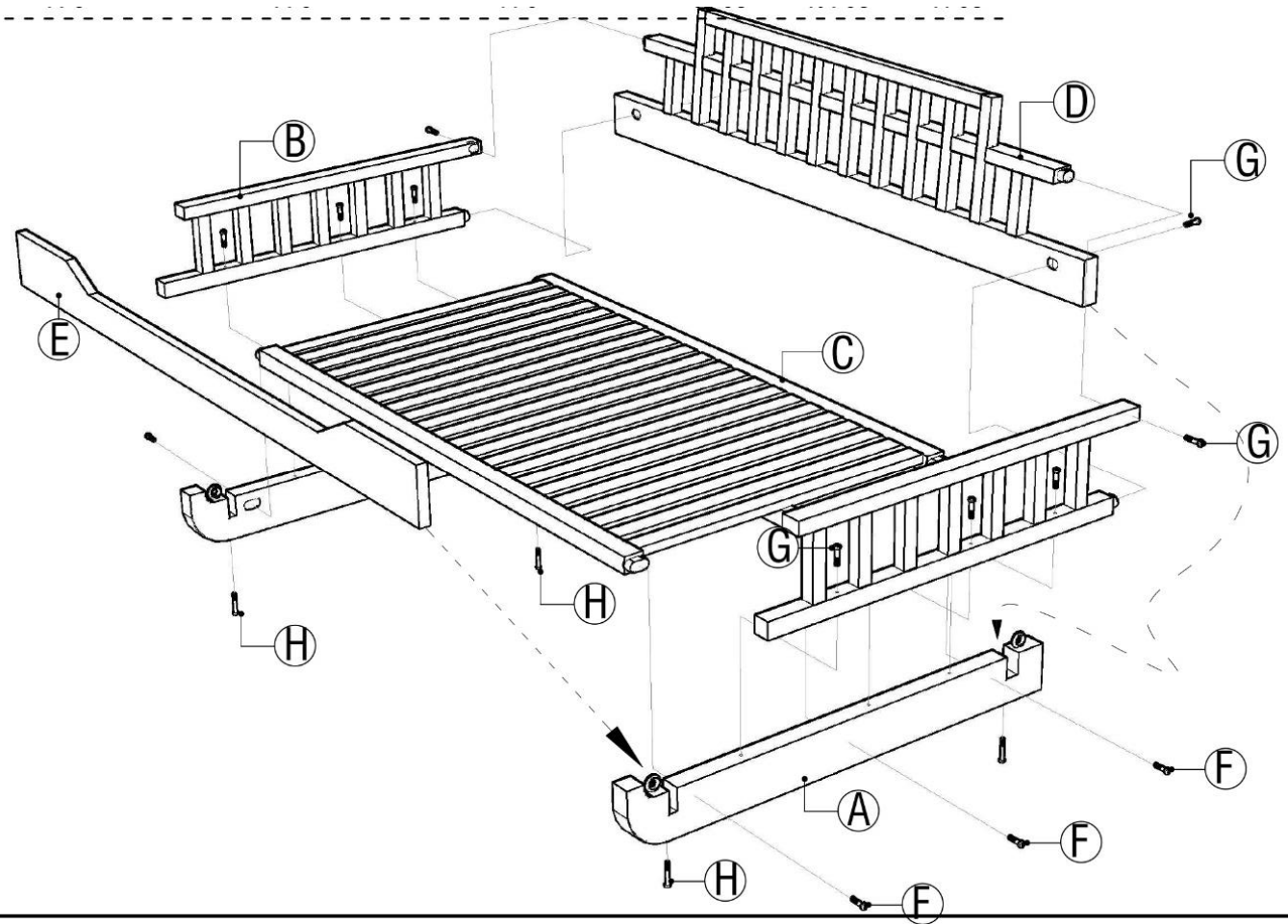

## INSTALLATION INSTRUCTIONS

---

### **STEP 1:**

Figure out where you want to hang your swing and locate the ceiling joists (studs) that line up closest to the chain hole dimensions of your swing. Most ceiling joists will not line up perfectly with the swing hole points; this is normal. In other words, when the holes on the swing are spaced at 84 inches apart, the closest joists will likely be spaced at 80" or 96" apart. You can either choose to have your chain angle out, or very slightly in (neither will affect the functionality of the swing). 80" is much closer to 84", so your chain angle won't be noticeable at all.

### **STEP 2:**

Pre-drill a hole in the center of the joist (if you have a ceiling or cannot access the joists, please contact a licensed contractor or handyman to install your hooks)

### **STEP 3:**

Install your 2-point lag screw eyes to the ceiling.

### **STEP 4:**

Loop the chain ends through the lag screw.

### **STEP 5:**

Place the frame of the bed on a 5-gallon bucket to help factor in the ideal height you would like the bed to hang from. Then attached the S hooks to the bed-base lag screw eye, you will then slide the chain directly to the swing hooks.

### **STEP 6:**

Place all provided cushions and pillows on the base, sit back, and relax!

## ACKNOWLEDGEMENT OF RISK AND RELEASE OF LIABILITY

---

The use of any equipment, including this one, involves the potential risk of injury. Apart from any warranty claim that might be presented for a claimed defect in material or workmanship of the product, you accept and assume full responsibility for any and all injuries, damages (both economic and non-economic), and losses of any type, which may occur, and you fully and forever release and discharge Titan, its insurers, employees, officers, directors, associates, and agents from any and all claims, demands, damages, rights of action, or causes of action, present or future, whether the same be known or unknown, anticipated, or unanticipated, resulting from or arising out of the use of said equipment.

This equipment must be used with care by capable and competent individuals under supervision, if necessary.

## WARNING

---



Heavy object. Use lifting aids and proper lifting techniques when moving.



Choking hazard. Small parts - Please exercise caution if small children or pets are present.



Sharp objects may be involved. Use precaution and protection.

## TITAN LIMITED WARRANTY: TERMS, EXCLUSIONS AND LIMITATIONS OF REMEDIES

---

This product comes with a one (1) year limited warranty that can be found at [www.titangreatoutdoors.com/warranty.html](http://www.titangreatoutdoors.com/warranty.html). Please review the same for all details regarding the Titan Limited Warranty.

**THE TITAN LIMITED WARRANTY FOUND AT [WWW.TITANGREATOUTDOORS.COM/WARRANTY.HTML](http://WWW.TITANGREATOUTDOORS.COM/WARRANTY.HTML) IS EXCLUSIVE AND IS IN LIEU OF ALL OTHER WARRANTIES, EXPRESS OR IMPLIED, INCLUDING ANY IMPLIED WARRANTY OF MERCHANTABILITY AND/OR FITNESS FOR A PARTICULAR PURPOSE, EACH OF WHICH IS HEREBY DISCLAIMED.**



**NEED HELP? CONTACT US FIRST.**

**1-888-794-1455**

[info@titangreatoutdoors.com](mailto:info@titangreatoutdoors.com)  
[www.titangreatoutdoors.com](http://www.titangreatoutdoors.com)

© 2021 Titan Brands