

# WEIGHT PLATE WALL STORAGE

---

PLATEWS4

400313



## Operator's Manual







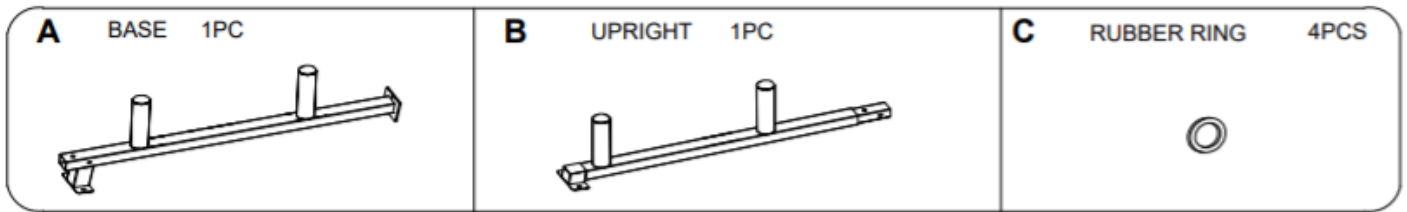

Read the Operator's Manual entirely. When you see this symbol, the subsequent instructions and warnings are serious follow without exception. Your life and the lives of others depend on it!

**PARTS DIAGRAM / EXPLODED VIEW**



**HARWARE PARTS LIST**

|  |   |  |  |
|--|---|--|--|
| <p><b>1</b><br/>BOLT(M10*60)</p>  <p>1PC</p>  | <p><b>2</b><br/>BOLT(M10*16)</p>  <p>1PC</p> | <p><b>3</b><br/>LAG BOLT(M8*70)</p>  <p>4PCS</p> | <p><b>4</b><br/>EXPANSION BOLT</p>  <p>2PCS</p> |
| <p><b>5</b><br/>WASHER(M10)</p>  <p>3PCS</p> | <p><b>6</b><br/>WASHER(M8)</p>  <p>4PCS</p> | <p><b>7</b><br/>NYLON NUT(M10)</p>  <p>1PC</p>  |  |

| KEY | DESCRIPTION     | QTY |
|-----|-----------------|-----|
| (A) | BASE            | 1   |
| (B) | UPRIGHT         | 1   |
| (C) | RUBBER RING     | 4   |
|     |                 |     |
| (1) | HEX BOLT M10*60 | 1   |
| (2) | HEX BOLT M10*16 | 1   |
| (3) | LAG BOLT M8*70  | 4   |
| (4) | EXPANSION BOLT  | 2   |
| (5) | WASHER M10      | 3   |
| (6) | WASHER M8       | 4   |
| (7) | NYLON NUT M10   | 1   |

# ASSEMBLY INSTRUCTIONS

---

## STEP 1

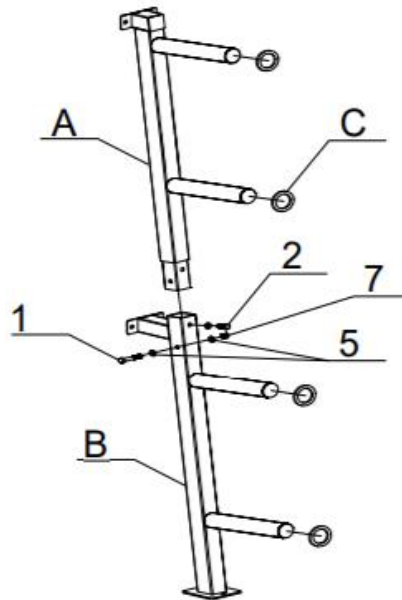

## STEP 2

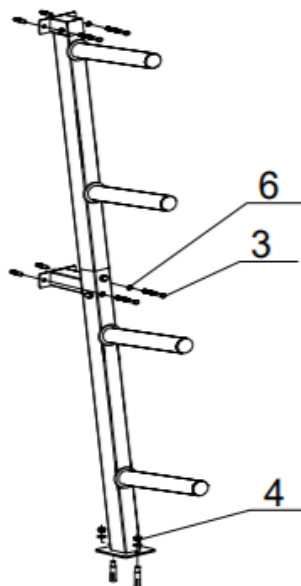

*NOTE: Please make sure to tighten all nut-and-bolt combinations before use.*

## ACKNOWLEDGEMENT OF RISK AND RELEASE OF LIABILITY

---

The use of any equipment, including this one, involves the potential risk of injury. Apart from any warranty claim that might be presented for a claimed defect in material or workmanship of the product, you accept and assume full responsibility for any and all injuries, damages (both economic and non-economic), and losses of any type, which may occur, and you fully and forever release and discharge Titan, its insurers, employees, officers, directors, associates, and agents from any and all claims, demands, damages, rights of action, or causes of action, present or future, whether the same be known or unknown, anticipated, or unanticipated, resulting from or arising out of the use of said equipment.

This equipment must be used with care by capable and competent individuals under supervision,

## WARNING

---



Heavy object. Use lifting aids and proper lifting techniques when moving.



Choking hazard. Small parts – Please exercise caution if small children or pets are present.



Sharp objects may be involved. Use precaution and protection.

## TITAN LIMITED WARRANTY: TERMS, EXCLUSIONS AND LIMITATIONS OF REMEDIES

---

This product comes with a one (1) year limited warranty that can be found at [www.titan.fitness/warranty.html](http://www.titan.fitness/warranty.html) Please review the same for all details regarding the Titan Limited Warranty.

**THE TITAN LIMITED WARRANTY FOUND AT [WWW.TITAN.FITNESS/WARRANTY](http://WWW.TITAN.FITNESS/WARRANTY) IS EXCLUSIVE AND IS IN LIEU OF ALL OTHER WARRANTIES, EXPRESS OR IMPLIED, INCLUDING ANY IMPLIED WARRANTY OF MERCHANTABILITY AND/OR FITNESS FOR A PARTICULAR PURPOSE, EACH OF WHICH IS HEREBY DISCLAIMED.**



**NEED HELP? CONTACT US FIRST.**

**1-888-410-1503**

**[info@titan.fitness](mailto:info@titan.fitness)**

**[www.titan.fitness](http://www.titan.fitness)**

**© 2021 Titan Brands**