

HYDRAULIC DUMP BOX

30HDUMPBOXv2

191509



Operator's Manual



Read the Operator's Manual entirely. When you see this symbol, the subsequent instructions and warnings are serious follow without exception. Your life and the lives of others depend on it!

PARTS DIAGRAM / EXPLODED VIEW

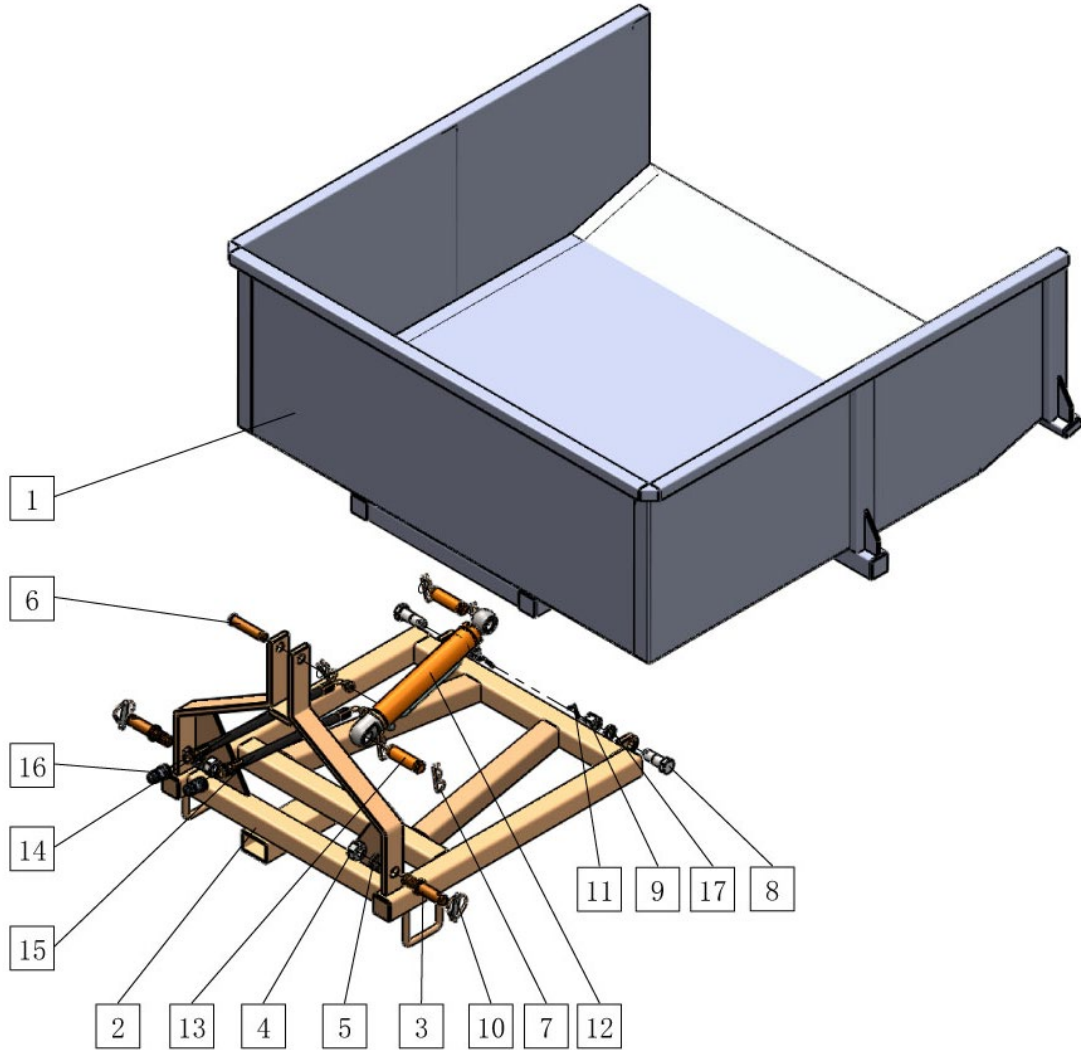

KEY	DESCRIPTION	QTY	KEY	DESCRIPTION	QTY
(1)	DUMP BOX	1	(10)	RING SHAPE LOCK PIN $\phi 9.5$	2
(2)	MAIN FRAME	1	(11)	COTTER PIN 4X45	2
(3)	TD LOWER PIN (TD104)	2	(12)	CYLINDER	1
(4)	HEX NUT M22	2	(13)	PIN SHAFT (30HDUMPBOX-3)	2
(5)	SPRING WASHER 22	2	(14)	OIL HOSE - RETURN	1
(6)	TD TOP PIN (TD105)	1	(15)	OIL HOSE - FEED	1
(7)	COTTER PIN 3.7x65	5	(16)	PIONEER COUPLER - MALE (KSA-08M)	2
(8)	HEX BOLT WITH HOLE M20X60	2	(17)	SPRING WASHER 20	2
(9)	HEX NUT WITH SLOT M20	2			

ASSEMBLY INSTRUCTIONS

- This product is sold as a completely assembled unit.

ACKNOWLEDGEMENT OF RISK AND RELEASE OF LIABILITY

The use of any equipment, including this one, involves the potential risk of injury. Apart from any warranty claim that might be presented for a claimed defect in material or workmanship of the product, you accept and assume full responsibility for any and all injuries, damages (both economic and non-economic), and losses of any type, which may occur, and you fully and forever release and discharge Titan, its insurers, employees, officers, directors, associates, and agents from any and all claims, demands, damages, rights of action, or causes of action, present or future, whether the same be known or unknown, anticipated, or unanticipated, resulting from or arising out of the use of said equipment.

This equipment must be used with care by capable and competent individuals under supervision, if necessary.

WARNING



Do not overfill! Mower should be level when checking oil in gear box.



some activities might be able to cause electric shock



Sharp objects may be involved.
Use protective cover during maintenance.

TITAN LIMITED WARRANTY: TERMS, EXCLUSIONS AND LIMITATIONS OF REMEDIES

This product comes with a one (1) year limited warranty that can be found at www.palletforks.com/warranty.html. Please review the same for all details regarding the Titan Limited Warranty.

THE TITAN LIMITED WARRANTY FOUND AT WWW.PALLETFORKS.COM/WARRANTY.HTML IS EXCLUSIVE AND IS IN LIEU OF ALL OTHER WARRANTIES, EXPRESS OR IMPLIED, INCLUDING ANY IMPLIED WARRANTY OF MERCHANTABILITY AND/OR FITNESS FOR A PARTICULAR PURPOSE, EACH OF WHICH IS HEREBY DISCLAIMED.



NEED HELP? CONTACT US FIRST.

1-800-605-7595

info@palletworks.com
www.palletforks.com

© 2021 Titan Brands