

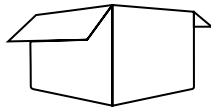

899507 - SEVLOUNGEWS\_AE











## Grade A Teak Sevilla Lounge Chair with Footstool





## UNBOXING

- A.** CHAIR BACK (1 PC)
- B.** LEFT & RIGHT CHAIR ARMS(2 PC)
- B1.** LEFT & RIGHT STOOL LEGS (2 PC)
- C.** CHAIR SEAT (1 PC)
- C1.** STOOL SEAT (1 PC)
- D.** WOODEN DOWELS (20 PC)
- E.** BOLT (2 PC)

<b>A</b>  <b>1 PC</b>	<b>B</b>  <b>2 PC</b>	<b>B1</b>  <b>2 PC</b>	<b>C</b>  <b>1 PC</b>	<b>C1</b>  <b>1PC</b>	<table border="1"> <tr> <td data-bbox="1307 105 1526 241">   <b>20 PC</b> </td> </tr> <tr> <td data-bbox="1307 241 1526 378"> <b>E</b>    <b>2 PC</b> </td> </tr> </table>	 <b>20 PC</b>	<b>E</b>  <b>2 PC</b>
 <b>20 PC</b>							
<b>E</b>  <b>2 PC</b>							

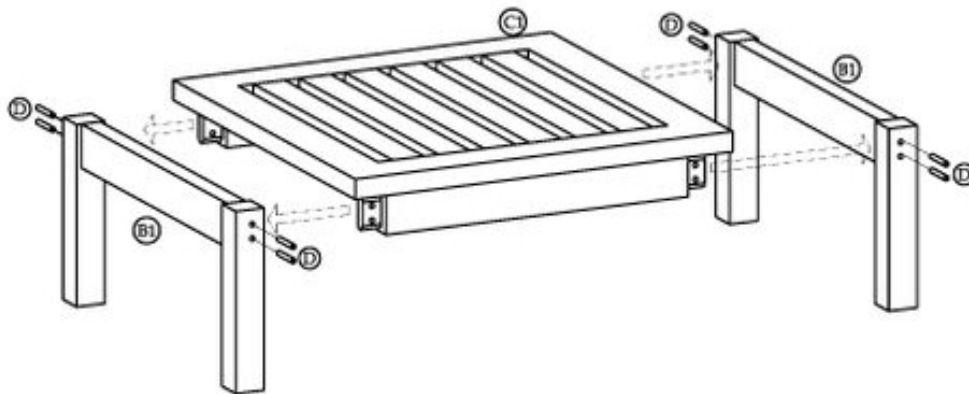
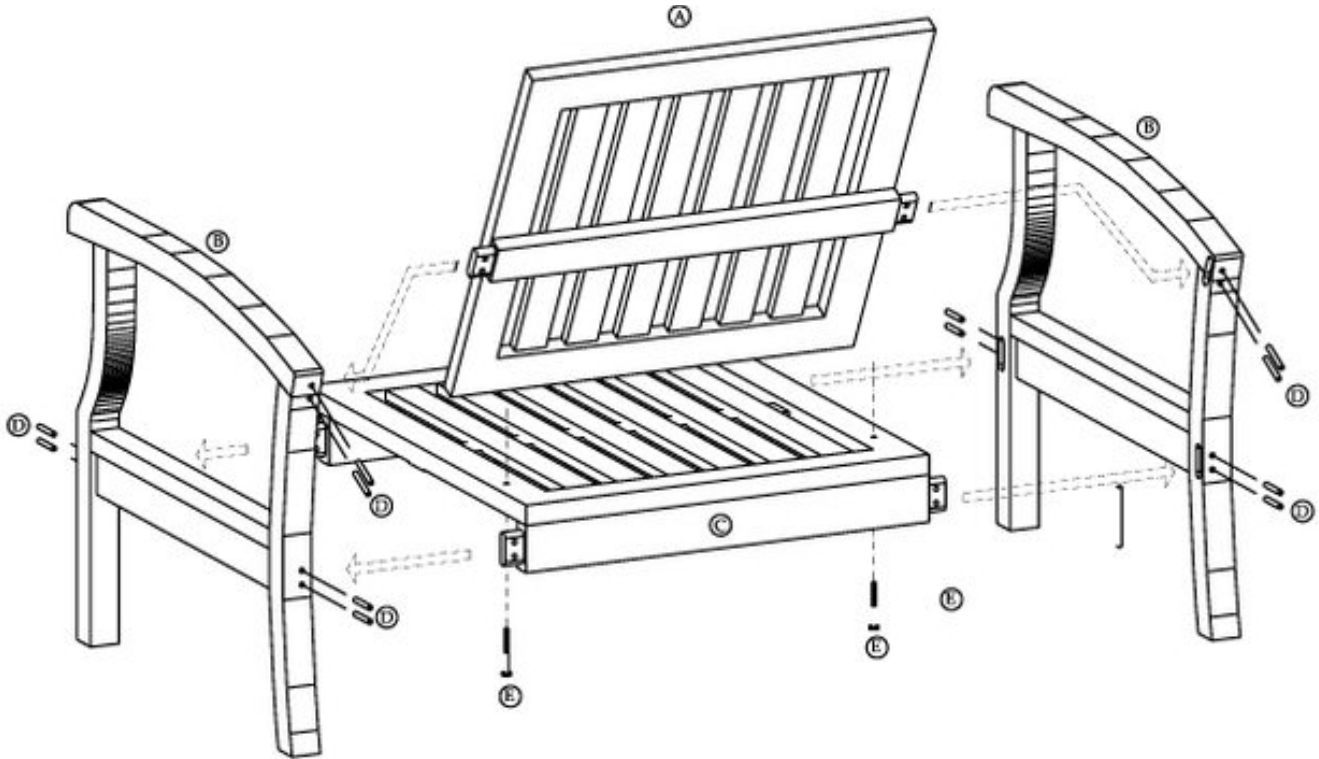

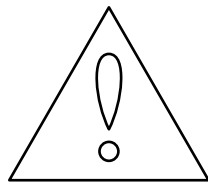

## WARNINGS



Heavy object. Use lifting aids and proper lifting techniques when moving.



Sharp objects may be involved. Use precaution and protection.



Choking hazard. Small parts - Please exercise caution if small children or pets are present.

## **Acknowledgement of Risk & Release of Liability**

The use of any equipment, including this one, involves the potential risk of injury. Apart from any warranty claim that might be presented for a claimed defect in material or workmanship of the product, you accept and assume full responsibility for any and all injuries, damages (both economic and non-economic), and losses of any type, which may occur, and you fully and forever release and discharge Titan, its insurers, employees, officers, directors, associates, and agents from any and all claims, demands, damages, rights of action, or causes of action, present or future, whether the same be known or unknown, anticipated, or unanticipated, resulting from or arising out of the use of said equipment. This equipment must be used with care by capable and competent individuals under supervision, if necessary.

## **Time Limited Warranty: Terms, Exclusions & Limitations of Remedies**

This product comes with a one (1) year limited warranty that can be found at [www.ashandemberoutdoors.com/warranty.html](http://www.ashandemberoutdoors.com/warranty.html). Please review the same for all details regarding the Titan Limited Warranty.

THE TITAN LIMITED WARRANTY FOUND AT [WWW.TITANGREATOUTDOORS.COM/WARRANTY.HTML](http://WWW.TITANGREATOUTDOORS.COM/WARRANTY.HTML) IS EXCLUSIVE AND IS IN LIEU OF ALL OTHER WARRANTIES, EXPRESS OR IMPLIED, INCLUDING ANY IMPLIED WARRANTY OF MERCHANTABILITY AND/OR FITNESS FOR A PARTICULAR PURPOSE, EACH OF WHICH IS HEREBY DISCLAIMED.

# ASH & EMBER

---

Need help? Contact us first.

PHONE

1-888-794-1455

EMAIL

[info@ashandemberoutdoors.com](mailto:info@ashandemberoutdoors.com)

ASH & EMBER

[www.ashandemberoutdoors.com](http://www.ashandemberoutdoors.com)