

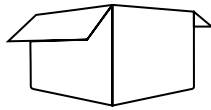

899613 - ALSUNSOFA

## Sun Sofa with Cushions















## UNBOXING

- A.** Front Seat Panel (1 Pc)
- B.** Back Seat Panel (1 Pc)
- C.** Front Feet (1 Pc)
- D.** Back Feet (1 Pc)
- E.** Middle Feet (1 Pc)
- F.** Gasket (16 Pc)

- G.** M6 x 30 Screw (8 Pc)
- H.** M6 x 15 Screw (8 Pc)
- I.** Backplane (3 Pc)
- J.** Spanner (1 Pc)

PARTS

A	 Front seat panel 1PC	B	 Back seat panel 1PC	C	 Front feet 1PC	D	 Back feet 1PC
E	 Middle feet 1PC	F	 Gasket 16PCS	G	 M6*30 screw 6PCS	H	 M3*15 screw 8PCS
I	 Backplane 3PCS	J	 Spanner 1PC				

STEP 1

Insert the front seat panel A to Back seat panel B directly and vertically, keeping the cloth on the same side

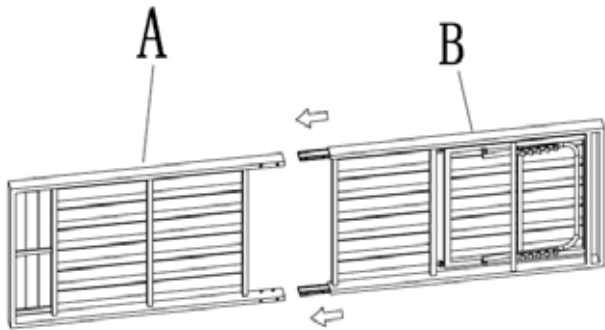

STEP 2

Then use 4pcs H screw with 4pcs Gasket F, and screw all four holes.

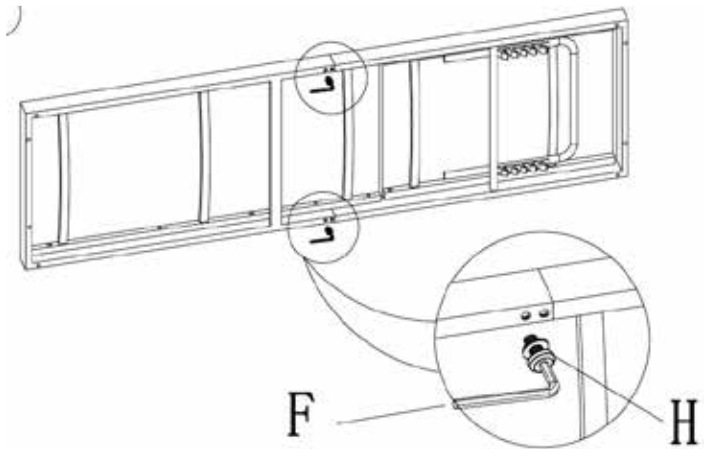

STEP 3

Assemble Front feet C to the bottom of Front seat panel, use 4pcs G screw with 6pcs Gasket F

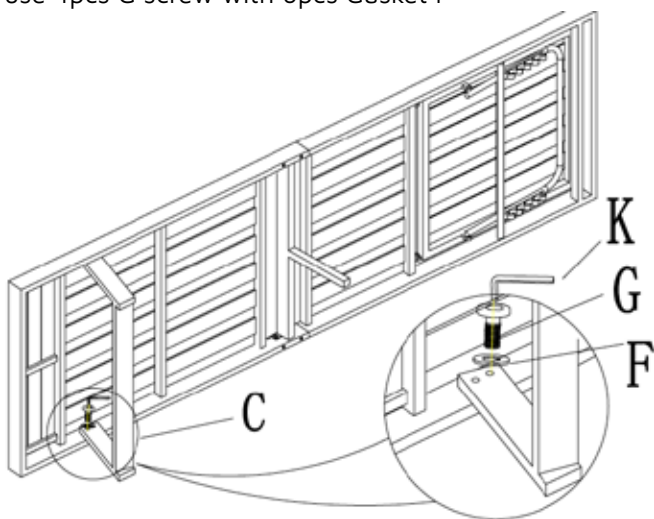

STEP 4

Assemble Back feet D to the bottom of Back seat panel, use 4pcs G screw with 6pcs Gasket F

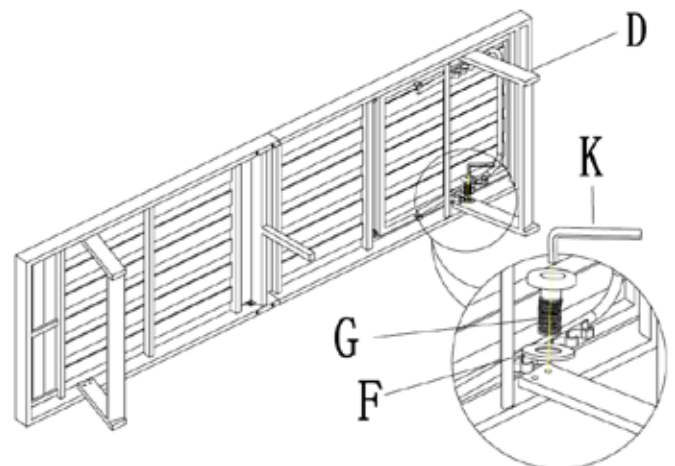

### STEP 5

Assemble Middle feet E to the Middle of seat panel, use 4pcs H screw with 6pcs Gasket F

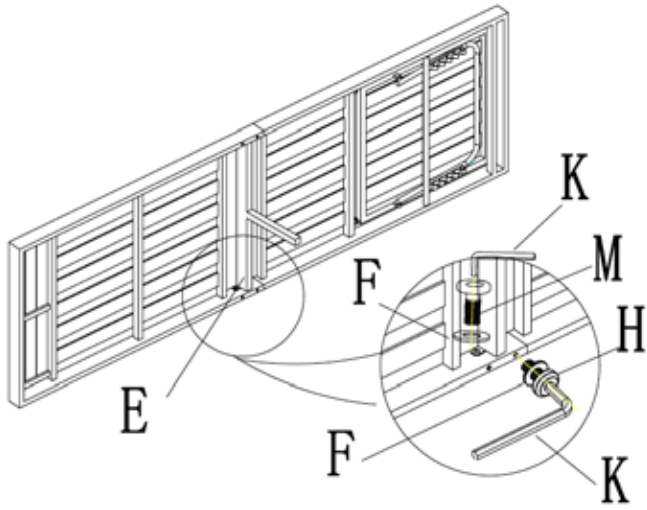

### STEP 6

After the main body is placed, use the back plate I, insert it directly into the seat tube, assemble the left and right back panels according to your preferences, and adjust the position.

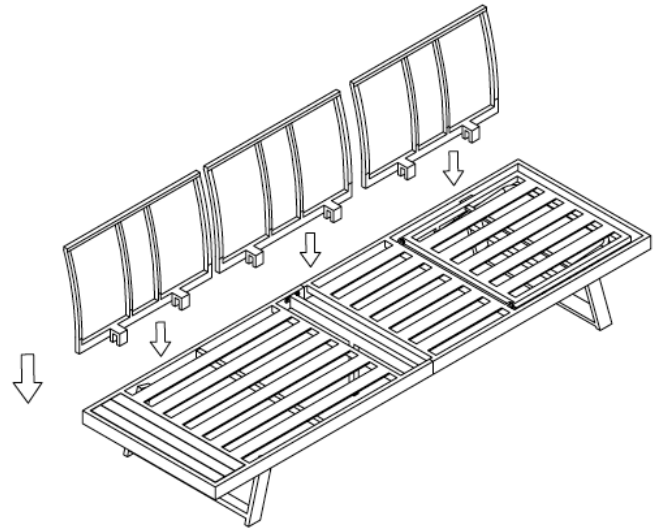

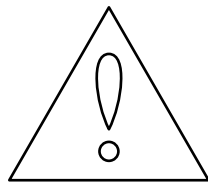

## WARNINGS



Heavy object. Use lifting aids and proper lifting techniques when moving.



Sharp objects may be involved. Use precaution and protection.



Choking hazard. Small parts - Please exercise caution if small children or pets are present.

## **Acknowledgement of Risk & Release of Liability**

The use of any equipment, including this one, involves the potential risk of injury. Apart from any warranty claim that might be presented for a claimed defect in material or workmanship of the product, you accept and assume full responsibility for any and all injuries, damages (both economic and non-economic), and losses of any type, which may occur, and you fully and forever release and discharge Titan, its insurers, employees, officers, directors, associates, and agents from any and all claims, demands, damages, rights of action, or causes of action, present or future, whether the same be known or unknown, anticipated, or unanticipated, resulting from or arising out of the use of said equipment. This equipment must be used with care by capable and competent individuals under supervision, if necessary.

## **Time Limited Warranty: Terms, Exclusions & Limitations of Remedies**

This product comes with a one (1) year limited warranty that can be found at [www.ashandemberoutdoors.com/warranty.html](http://www.ashandemberoutdoors.com/warranty.html). Please review the same for all details regarding the Titan Limited Warranty.

THE TITAN LIMITED WARRANTY FOUND AT [WWW.TITANGREATOUTDOORS.COM/WARRANTY.HTML](http://WWW.TITANGREATOUTDOORS.COM/WARRANTY.HTML) IS EXCLUSIVE AND IS IN LIEU OF ALL OTHER WARRANTIES, EXPRESS OR IMPLIED, INCLUDING ANY IMPLIED WARRANTY OF MERCHANTABILITY AND/OR FITNESS FOR A PARTICULAR PURPOSE, EACH OF WHICH IS HEREBY DISCLAIMED.

# ASH & EMBER

---

Need help? Contact us first.

PHONE

1-888-794-1455

EMAIL

[info@ashandemberoutdoors.com](mailto:info@ashandemberoutdoors.com)

ASH & EMBER

[www.ashandemberoutdoors.com](http://www.ashandemberoutdoors.com)