

LAT TOWER | 10 LB - 300 LB SELECTOR

LATTWRKITv2

401756















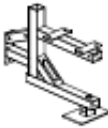
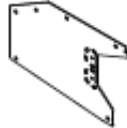











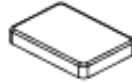

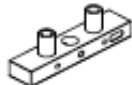



Operator's Manual







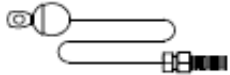
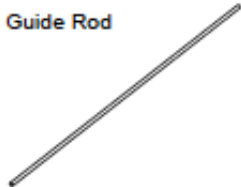



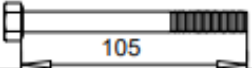
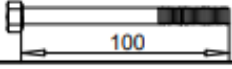
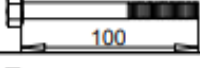
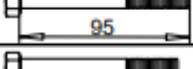
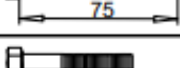

Read the Operator's Manual entirely. When you see this symbol, the subsequent instructions and warnings are serious follow without exception. Your life and the lives of others depend on it!

PARTS DIAGRAM / EXPLODED VIEW

Item 1. Rear Base 	Qty 1	Item 2. Rear Upright 	Qty 1	Item 3. Bottom Cross Base 	Qty 1	Item 4. Front Upright 	Qty 1	Item 5. Top Cross Beam 	Qty 1
Item 6. Pad Support Frame 	Qty 1	Item 7. Big Plate 	Qty 2	Item 8. Adjustable Tube 	Qty 1	Item 9. Foot Plate 	Qty 1	Item 10. Adjustable Foam Frame 	Qty 1
Item 11 A/B. Wheel Fixed Board 	Qty 2	Item 12. Reinforced Plate 	Qty 2	Item 13. Guide Rod Fixed Plate 	Qty 2	Item 14. Lat Bar 	Qty 1	Item 15. Wheel 	Qty 9
Item 16. Wheel bracket 	Qty 2	Item 17. End Cover 	Qty 2	Item 18. Foam roller 	Qty 2	Item 19. Pad 	Qty 1	Item 20. Weight Plate (No.2-30) 	Qty 29
Item 21. Top Weight Plate (No.1) 	Qty 1	Item 22. Weight Selector 	Qty 1	Item 23. Pin 	Qty 1	Item 24. Screw Rod 	Qty 4	Item 25. Rod (20CM) 	Qty 2
Item 26. Limit Ring 	Qty 8	Item 27. Metal Sleeve(22) 	Qty 2	Item 28. Metal Sleeve(12) 	Qty 4	Item 29. Nylon Sleeve(48mm) 	Qty 1	Item 30. Nylon Sleeve(88mm) 	Qty 1
Item 31. Safe knot 	Qty 3	Item 32. Chain 	Qty 1	Item 33. Rubber Bumper 	Qty 2	Item 34. Cable(3355mm) 	Qty 2	Item 35. Guide Rod 	Qty 2

KEY	DESCRIPTION	QTY	KEY	DESCRIPTION	QTY
1	REAR BASE	1	19	PAD	1
2	REAR UPRIGHT	1	20	WEIGHT PLATE (NO. 2-30)	29
3	BOTTOM CROSS BASE	1	21	TOP WEIGHT PLATE (NO.1)	1
4	FRONT UPRIGHT	1	22	WEIGHT SELECTOR	1
5	TOP CROSS BEAM	1	23	PIN	1
6	PAD SUPPORT FRAME	1	24	SCREW ROD	4
7	BIG PLATE	2	25	ROD (20 CM)	2
8	ADJUSTABLE TUBE	1	26	LIMIT RING	8
9	FOOT PLATE	1	27	METAL SLEEVE (22)	2
10	ADJUSTABLE FOAM FRAME	1	28	METAL SLEEVE (12)	4
11	WHEEL FIXED BOARD 1 PAIR	2	29	NYLON SLEEVE (48)	1
12	REINFORCED PLATE	2	30	NYLON SLEEVE (68)	1
13	GUIDE ROD FIXED PLATE	2	31	SAFETY BUCKLE	3
14	LAT BAR	1	32	CHAIN	1
15	WHEEL	9	33	RUBBER BUMPER	2
16	WHEEL BRACKET	2	34	CABLE	2
17	END COVER	2	35	GUIDE ROD	2
18	FOAM ROLLER	2			

HARDWARE LIST

Item	Description	Qty	Drawing
36	M12*105mm bolt	9	
37	M12*100mm bolt	6	
38	M10*100mm bolt	4	
39	M10*95mm bolt	2	
40	M10*75mm bolt	9	
41	M10*50mm bolt	8	
42	M10*30mm bolt	6	
43	M10*16mm bolt	2	
44	M6*5mm set screw	8	
Washers			
45	M12 washer	29	
46	M10 washer	50	
Nuts			
47	M12 Nylon locknut	14	
48	M10 Nylon locknut	22	
Knob			
49	M16 knob	2	
50	M10 Magnetic pin	1	

ASSEMBLY INSTRUCTIONS

STEP 1

1. Attach Rear Upright (2) to Rear Base (1) using M12 x 100mm bolt (37), M12 Washer (45) and M12 Nylon locknut (47).

STEP 2

1. Attach Bottom Cross Base (3) to Rear Upright (2) using M12 x 100mm bolt (37), M12 Washer (45) and M12 Nylon locknut (47) and then attach the other end of the Cross Base (3), the Pad Support Frame (6) to Front Upright (4) using M12 x 105mm bolt (36), M12 Washer (45) and M12 Nylon locknut (47).

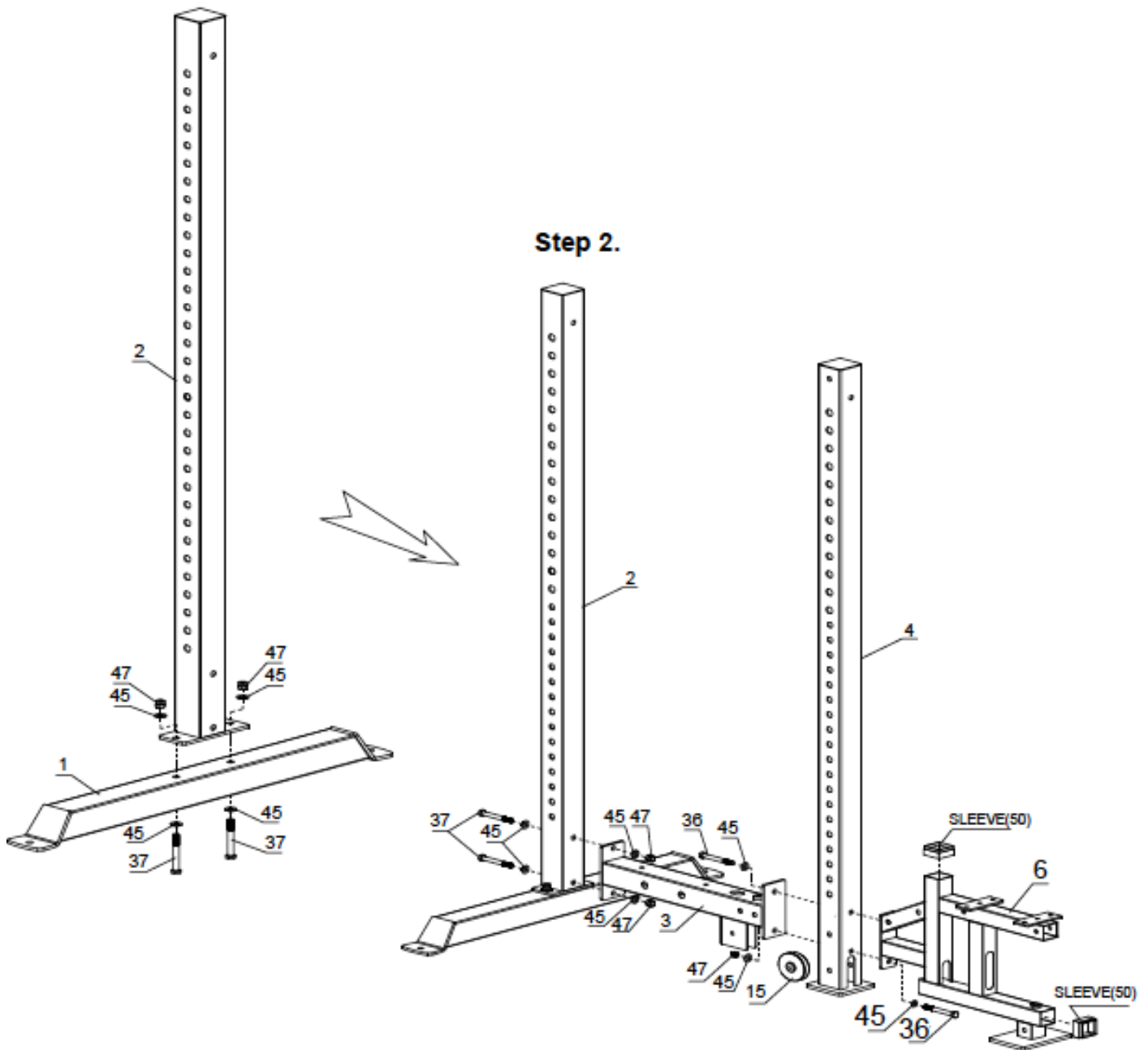

STEP 3

1. Attach Guide Rod Fixed Plate (13) to Bottom Cross Base (3) using M10 x 100mm bolt (38), M10 Washer (46) and M10 Nylon locknut (48).
2. Insert the Rod (20CM) (25) through hole of the Bottom Cross Base (3) using M10 x 50mm bolt (41). Then attach Limit Ring (26) to ends of the Rod (20CM) (25) using M6*5mm Set Screw (44).

STEP 3

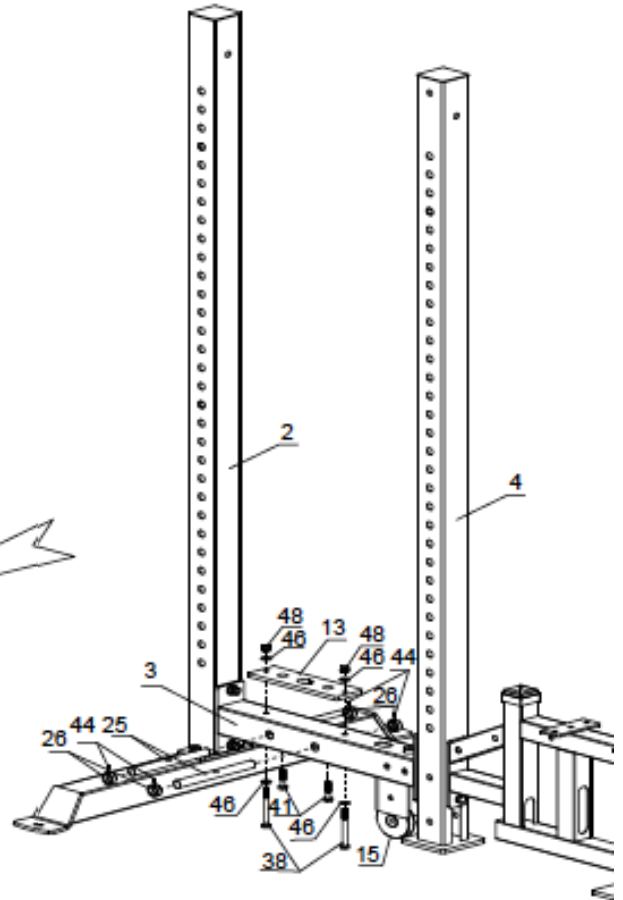

Step 4.

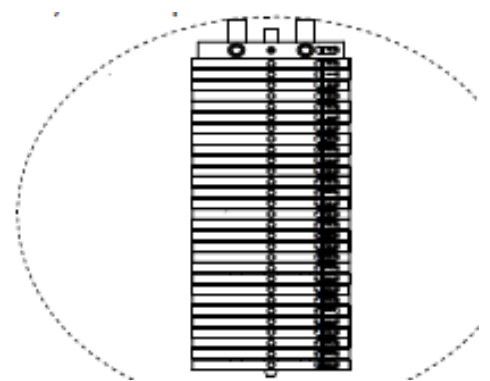
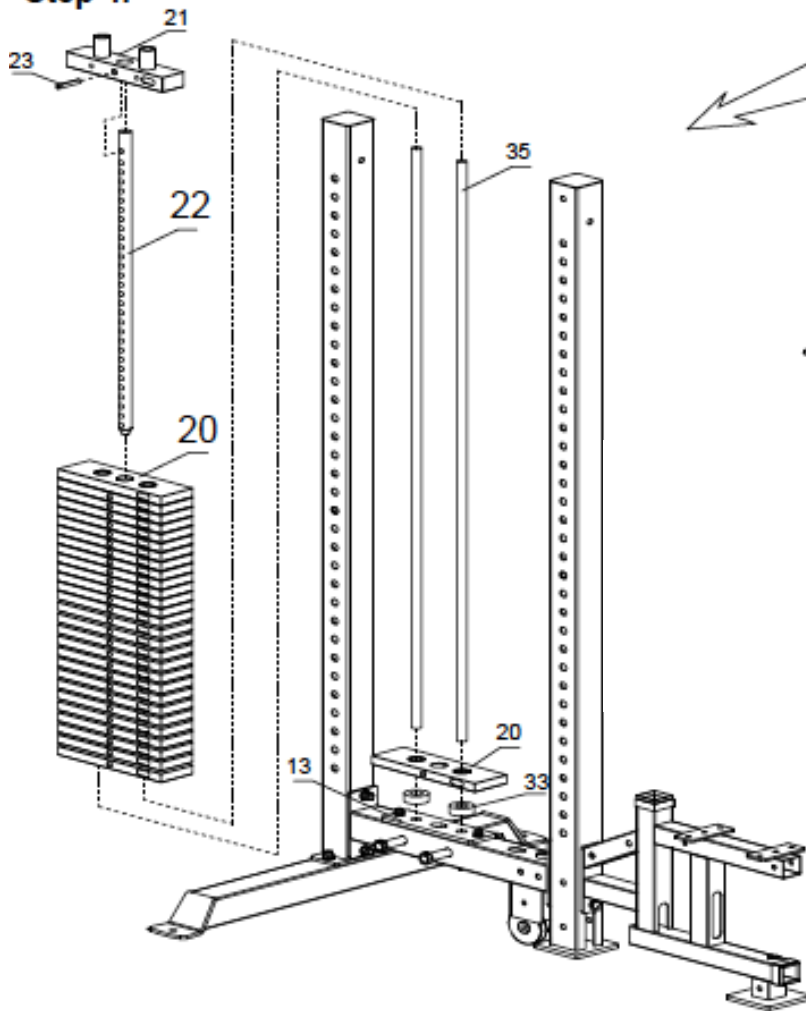

STEP 4

1. Insert Weight Selector (22) into hole of the Top Weight Plate (21) using the Pin (23)
2. Put the Rubber Bumper (33), Weight (20) (No.30) on the Guide Rod Fixed Plate (13) and insert one end of Guide Rod (35) into the holes (Ø21MM). Next, slide the weight plates (20) down the Guide Rods (13) in this order - 29pcs Weight Plates (20) (No.30-2) and the Top Weight Plate (21) (No.1).

STEP 5

1. Attach the Top Cross Beam (5) to the Rear Upright (2) and Front Upright (4) using M12 x 100mm bolt (37), M12 Washer (45) and M12 Nylon locknut (47).
2. Insert the other end of the Guide Rod (35) through the hole of Guide Rod Fixed Plate (13) and attach them to Top Cross Beam (5) using M10 x 100mm bolt (38), M10 Washer (46) and M10 Nylon locknut (48).

STEP 6

1. Attach the Wheel Fixed Board (11AB) to the Top Cross Beam (5) using M12 x 105mm bolt (36), M12 Washer (45) and M12 Nylon locknut (47).

Step 5.

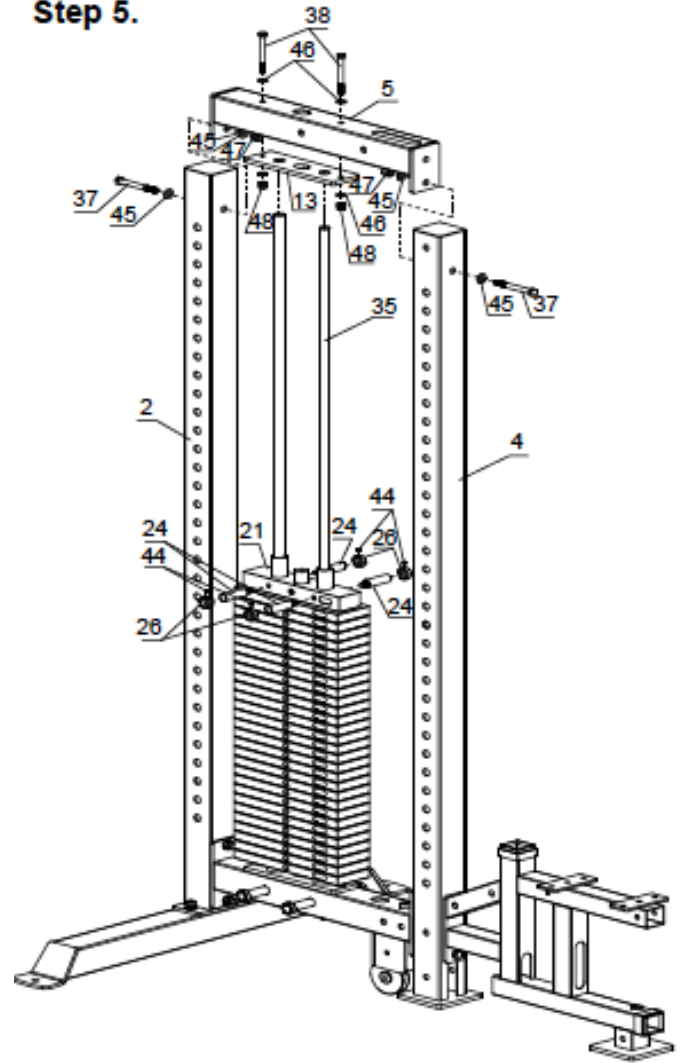

Step 6.

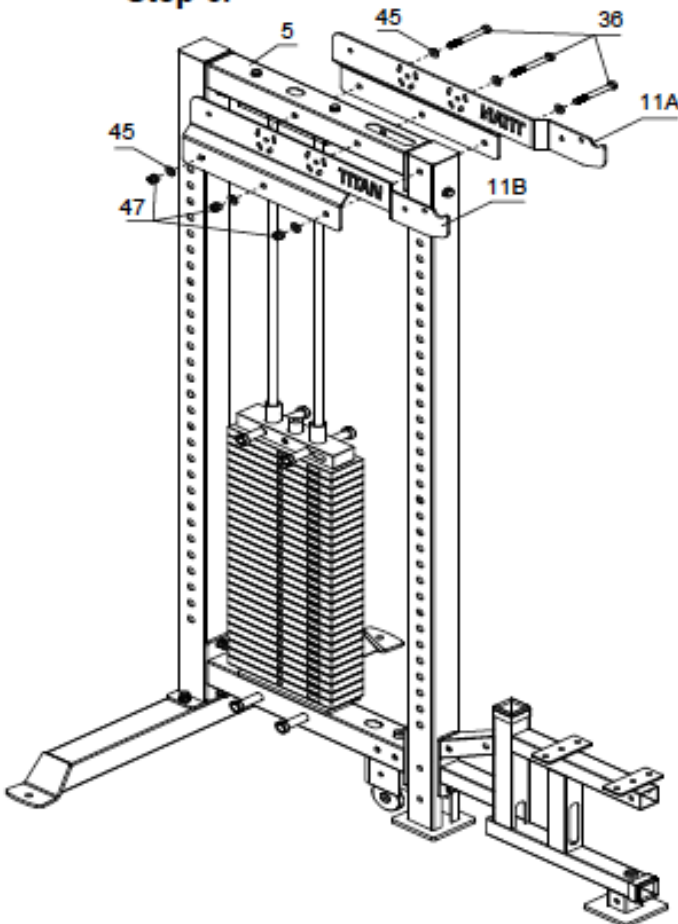

STEP 7

1. Attach the Big Plate (7), Nylon Sleeve (48mm) (29) to Pad Support Frame (6) using M10 x 75mm bolt (40), M10 Washer (46) and M10 Nylon locknut (48).

STEP 8

1. Attach the Reinforced Plate (12) to Bottom Cross Base (3), Front Upright (4) using M12 x 105mm bolt (36), M12 Washer (45) and M12 Nylon locknut (47).
2. Insert the Adjustable Foam Frame (10) into the Pad Support Frame (6) using M16 Knob (49) then push the Foam roller (18) on the ends using End Cover (17), M10 Washer (46) and M10*30 bolt (42).
3. Attach the Foot Plate (9) to Adjustable Tube (8) using M10 x 16mm bolt (43), M10 Washer (46) and M10 Nylon locknut (48) and insert the Adjustable Tube (8) into the Pad Support Frame (6) using M16 Knob (49).
4. Attach the Pad (19) to the Pad Support Frame (6) using M10 Washer (46), M10 x 30mm bolt (42).

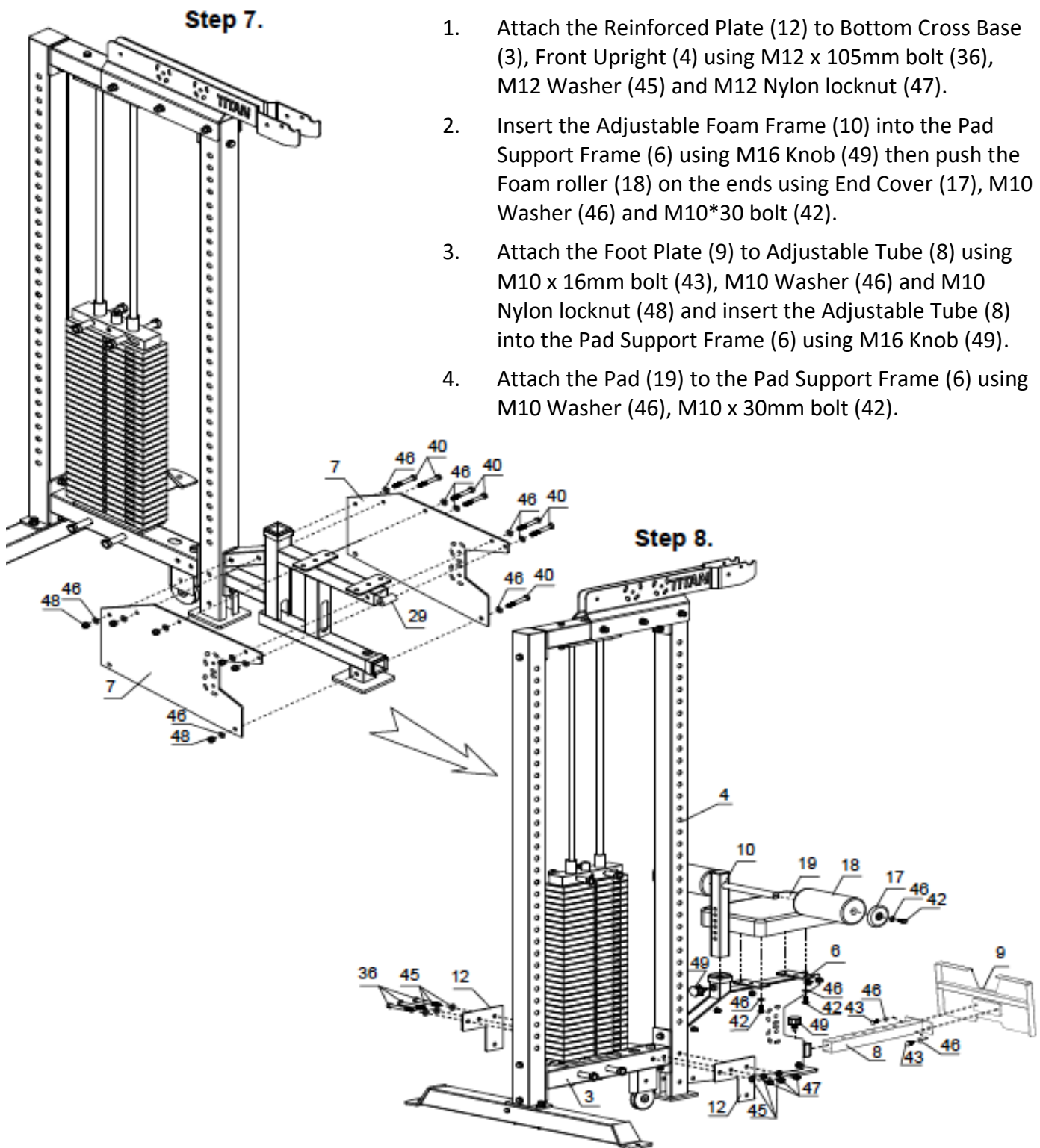

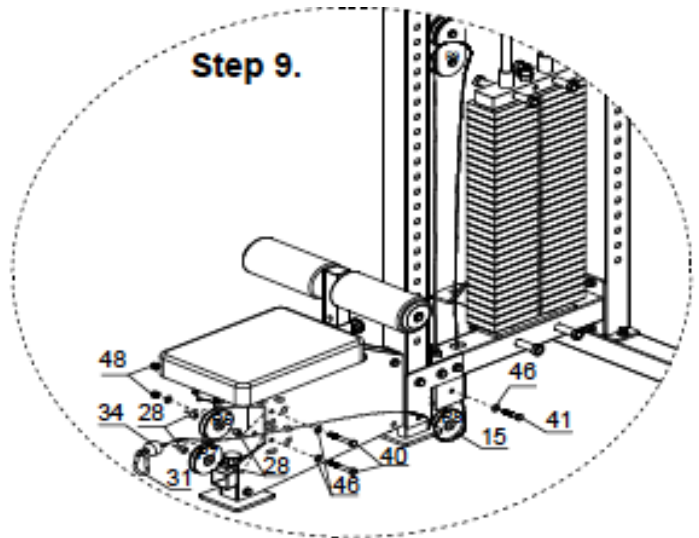
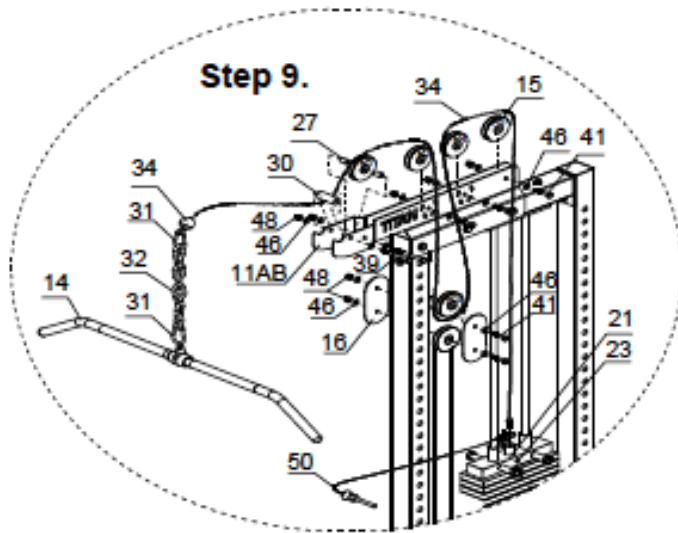

1. Assemble the Nylon Sleeve(68mm) (30) to the Wheel Fixed Board (11A&B) using M10x95mm bolt (39), M10 Washer (46) and M10 Nylon Locknut (48).
2. Assemble one Wheel (15) at the Position P1 using M10 x 95mm bolt (39), Metal Sleeve (27), M10 Washer (46) and M10 Nylon Locknut (48).
3. Assemble two Wheels (15) at the Position P6/P7 using M10 x 75mm bolt (40), Metal Sleeve (28), M10 Washer (46) and M10 Nylon Locknut (48).
4. Assemble other Wheels (15) at the Position P2/3/4/5/8/9 using M10 x 50mm bolt (41), M10 Washer (46) and M10 Nylon Locknut (48).
5. Install one Cable (34) follow this route: Take one end of cable with bolt pass over the Wheel (P1), above P2, below P3, above P4, above P5, then screw the bolt into the hole of the Weight Selector (22).
6. Install another Cable (34) follow this route: Take one end of cable with bolt pass through the Wheel (P6&7), below P8, above P9, then screw the bolt into the hole of the Bottom Cross Base (3).
7. Connect the Lat Bar (14) to the end of Cable (34) using Safety Knot (31) and Chain (32).

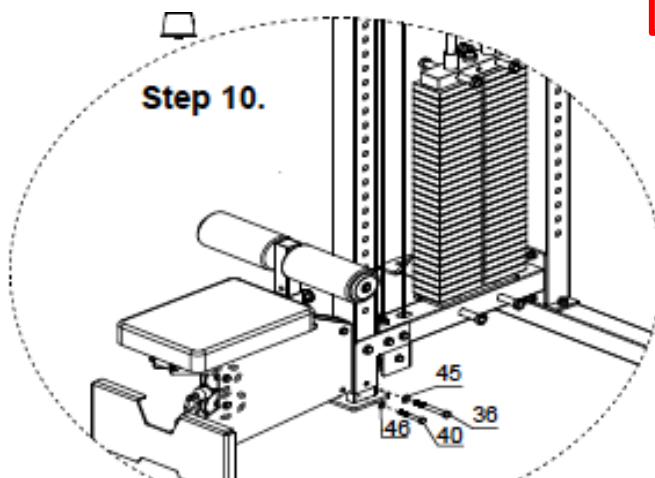
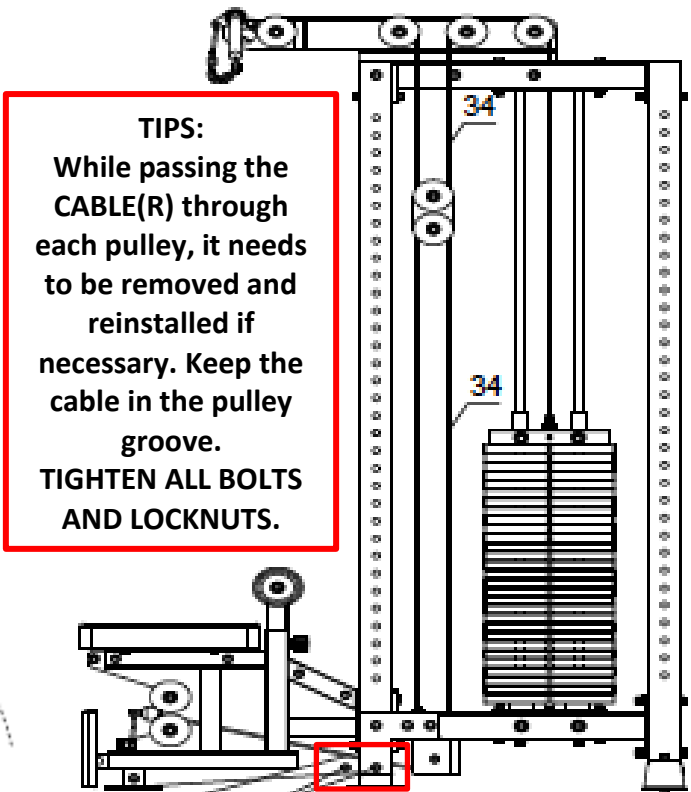

The cable must be installed above these two bolts

ACKNOWLEDGEMENT OF RISK AND RELEASE OF LIABILITY

The use of any equipment, including this one, involves the potential risk of injury. Apart from any warranty claim that might be presented for a claimed defect in material or workmanship of the product, you accept and assume full responsibility for any and all injuries, damages (both economic and non-economic), and losses of any type, which may occur, and you fully and forever release and discharge Titan, its insurers, employees, officers, directors, associates, and agents from any and all claims, demands, damages, rights of action, or causes of action, present or future, whether the same be known or unknown, anticipated, or unanticipated, resulting from or arising out of the use of said equipment.

This equipment must be used with care by capable and competent individuals under supervision,

WARNING



Heavy object. Use lifting aids and proper lifting techniques when moving.



Choking hazard. Small parts – Please exercise caution if small children or pets are present.



Sharp objects may be involved. Use precaution and protection.

TITAN LIMITED WARRANTY: TERMS, EXCLUSIONS AND LIMITATIONS OF REMEDIES

This product comes with a one (1) year limited warranty that can be found at www.titan.fitness/warranty.html Please review the same for all details regarding the Titan Limited Warranty.

THE TITAN LIMITED WARRANTY FOUND AT WWW.TITAN.FITNESS/WARRANTY IS EXCLUSIVE AND IS IN LIEU OF ALL OTHER WARRANTIES, EXPRESS OR IMPLIED, INCLUDING ANY IMPLIED WARRANTY OF MERCHANTABILITY AND/OR FITNESS FOR A PARTICULAR PURPOSE, EACH OF WHICH IS HEREBY DISCLAIMED.



NEED HELP? CONTACT US FIRST.

1-888-410-1503

info@titan.fitness

www.titan.fitness

© 2023 Titan Brands