

ELITE SERIES ADJUSTABLE FID BENCH

ESFIDBENCH

401912





















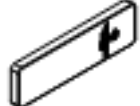













Operator's Manual



Read the Operator's Manual entirely. When you see this symbol, the subsequent instructions and warnings are serious follow without exception. Your life and the lives of others depend on it!

PARTS DIAGRAM / EXPLODED VIEW

A REAR BASE 1PC 	B MAIN FRAME 1PC 	C ADJUSTER 1PC 	D SEAT ADJUSTMENT 1PC 
E LEFT ADJUSTABLE PLATE 1PC 	F RIGHT ADJUSTABLE PLATE 1PC 	G SEAT SUPPORT 1PC 	H BACKREST SUPPORT 2PCS 
I BACKREST ADJUSTMENT 1PC 	J CONNECT PATE 1PC 	K LEG EXTENSION 1PC 	L BACKREST 1PC 
M SEAT PAD 1PC 	N FOAM ROLLER 2PCS 	O FOAM PLUG 2PCS 	P BUSH 6PCS 
Q KNOB(M20) 1PC 			
1 BOLT M12*110 2PCS 	2 BOLT M12*100 5PCS 	3 BOLT M12*95 1PC 	4 BOLT M10*110 1PC 
5 BOLT M10*65 4PCS 	6 BOLT M10*25 2PCS 	7 BOLT M10*20 7PCS 	8 BOLT M6*12 4PCS 
9 SHAFT(149MM) 2PCS 	10 LOCK NUT M12 8PCS 	11 LOCK NUT M10 1PC 	12 WASHER φ12 16PCS 
13 WASHER φ10 12PCS 	14 BIG WASHER φ6 4PCS 	15 THRUST WASHER 4PCS 	16 NYLON WASHER φ10 2PCS 

ITEM NO.	DESCRIPTION	QTY
A	REAR BASE	1
R	MAIN FRAME	1
C	ADJUSTER (OUTER)	1
D	SEAT ADJUSTMENT	1
E	LEFT ADJUSTABLE PLATE	1
F	RIGHT ADJUSTABLE PLATE	1
G	SEAT SUPPORT	1
H	BACKREST SUPPORT	2
I	BACKREST ADJUSTMENT	1
J	CONNECT PATE	1
K	LEG EXTENSION	1
L	BACKREST	1
M	SEAT PAD	1
N	FOAM ROLLER	2
O	FOAM PLUG	2
P	BUSH	6
Q	KNOB (M20)	1
1	HEX BOLT M12*110	2
2	HEX BOLT M12*100	5
3	HEX BOLT M12*95	1
4	HEX BOLT M10*110	1
5	HEX BOLT M10*65	4
6	HEX BOLT M10*25	2
7	HEX BOLT M10*20	7
8	HEX BOLT M6*12	4
9	SHAFT (149MM)	2
10	LOCK NUT M12	8
11	LOCK NUT M10	1
12	WASHER ϕ 12	16
13	WASHER ϕ 10	12
14	BIG WASHER ϕ 6	4
15	THRUST WASHER	4
16	NYLON WASHER ϕ 10	2

ASSEMBLY INSTRUCTIONS

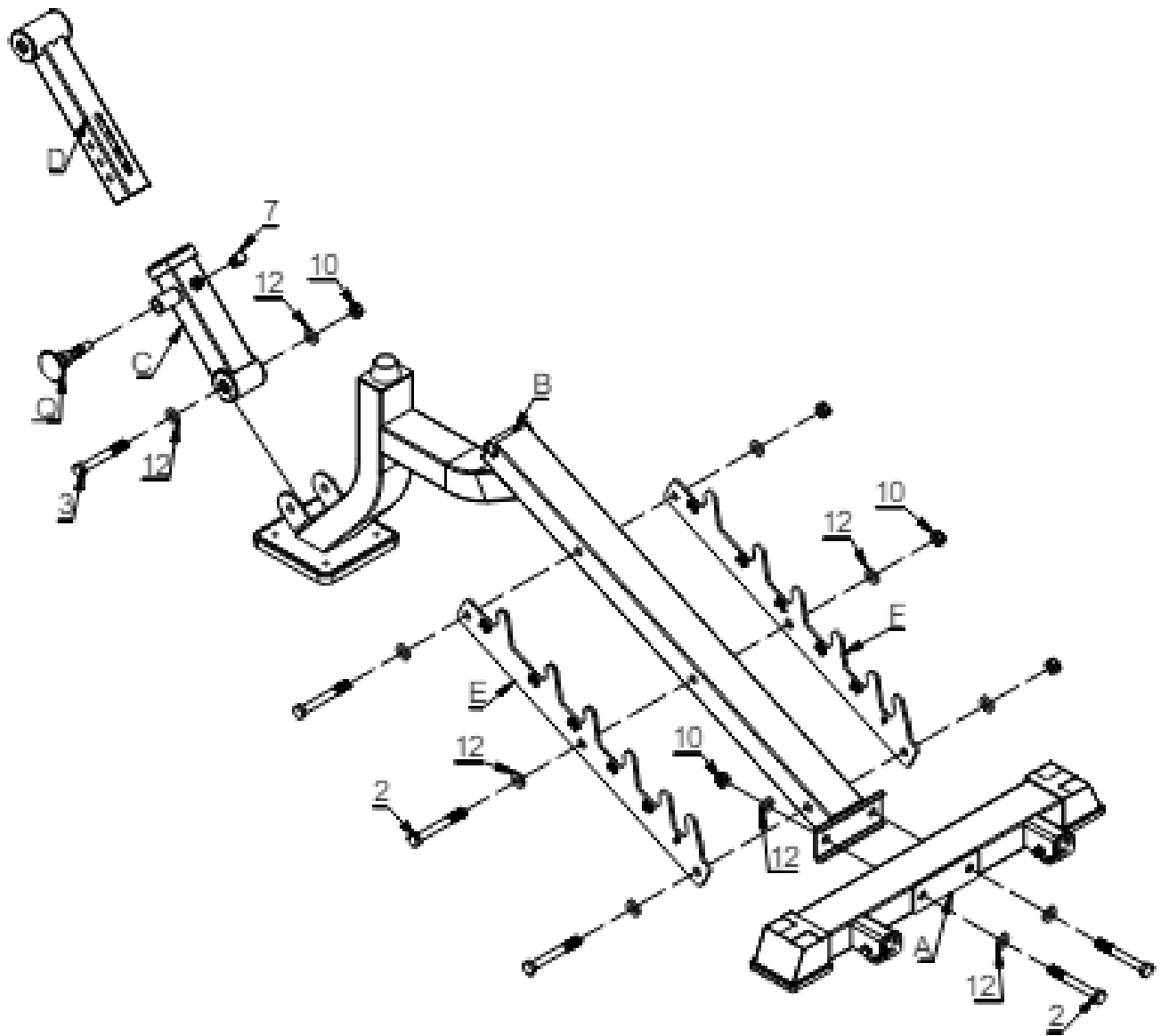

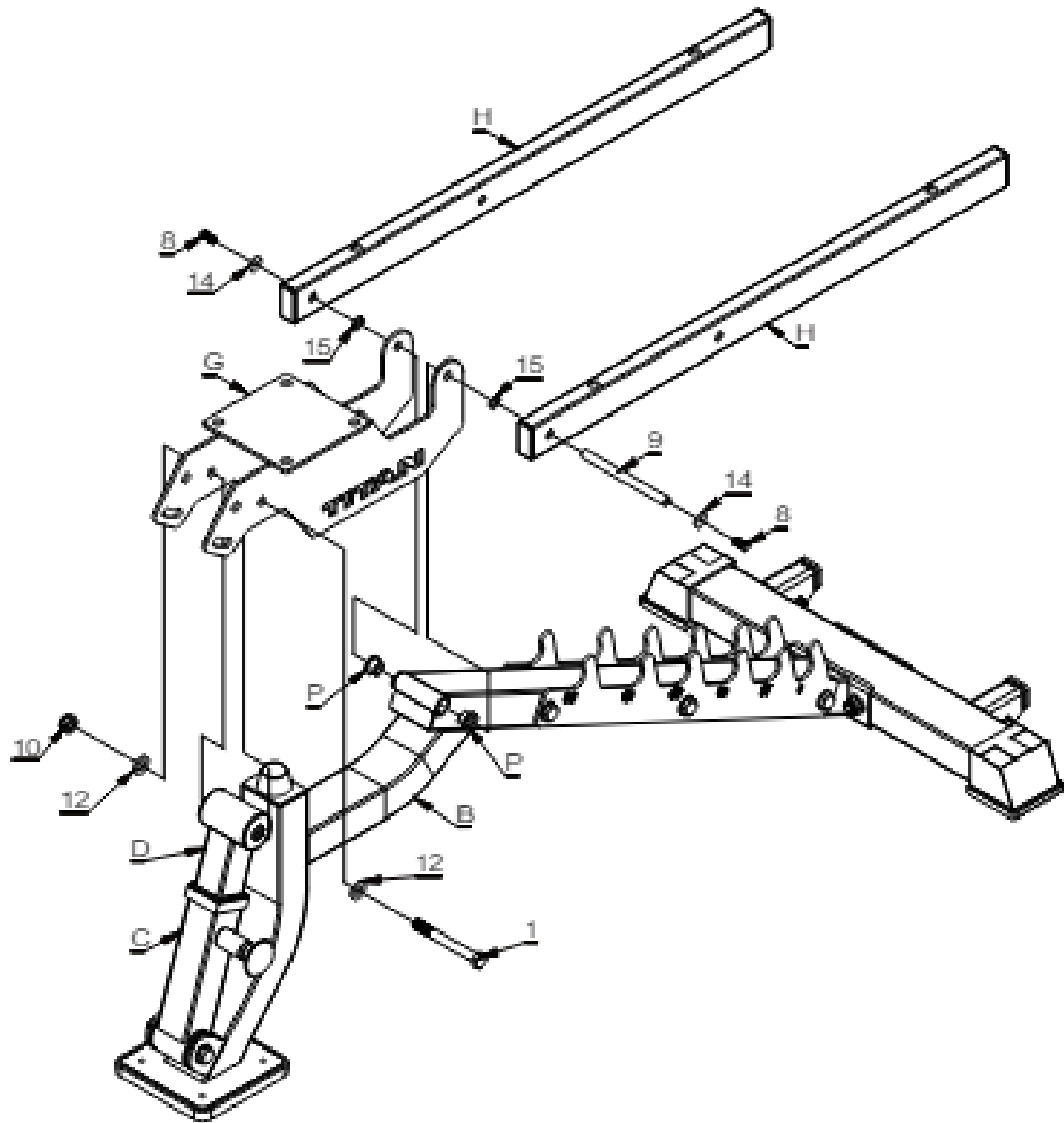

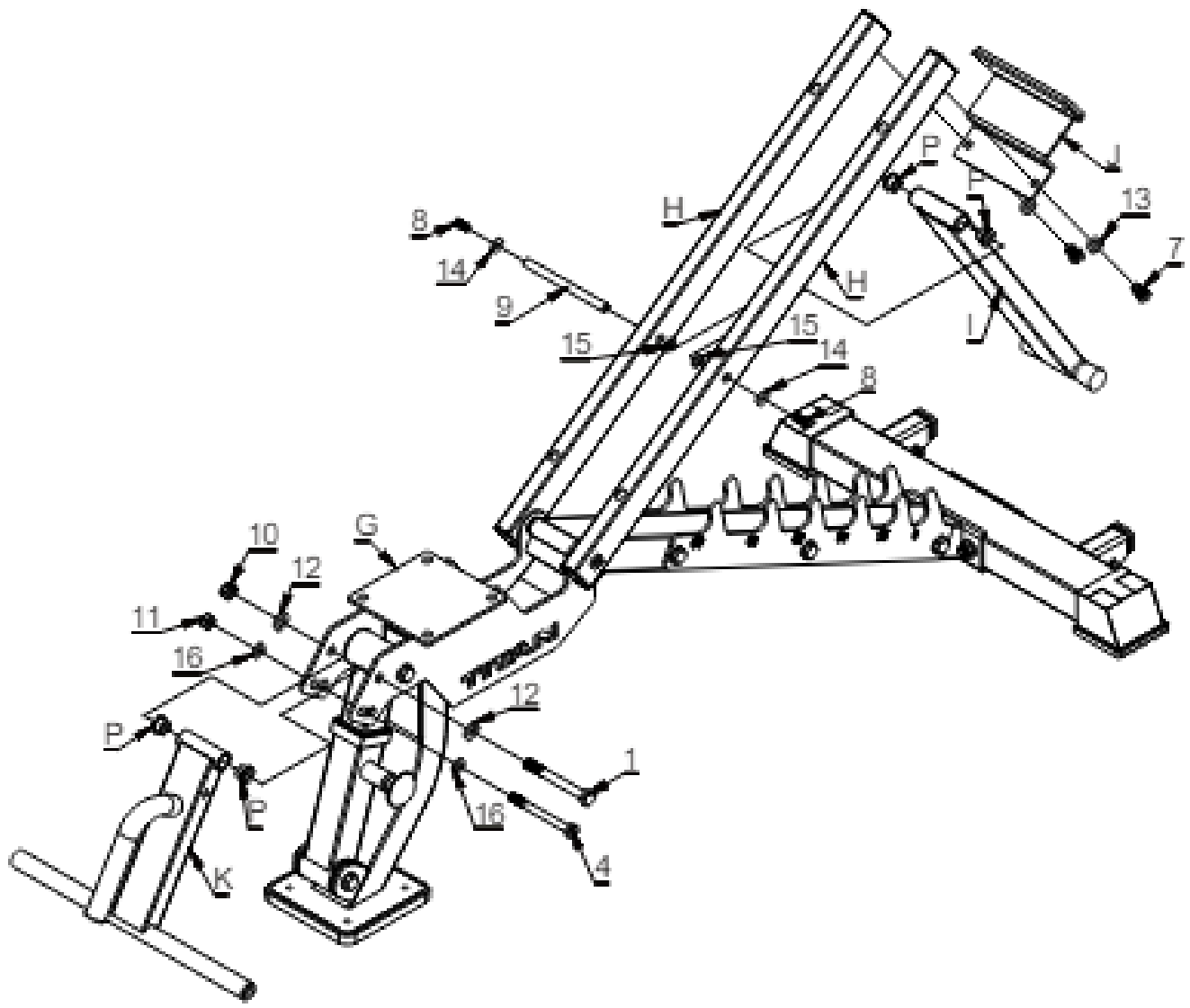

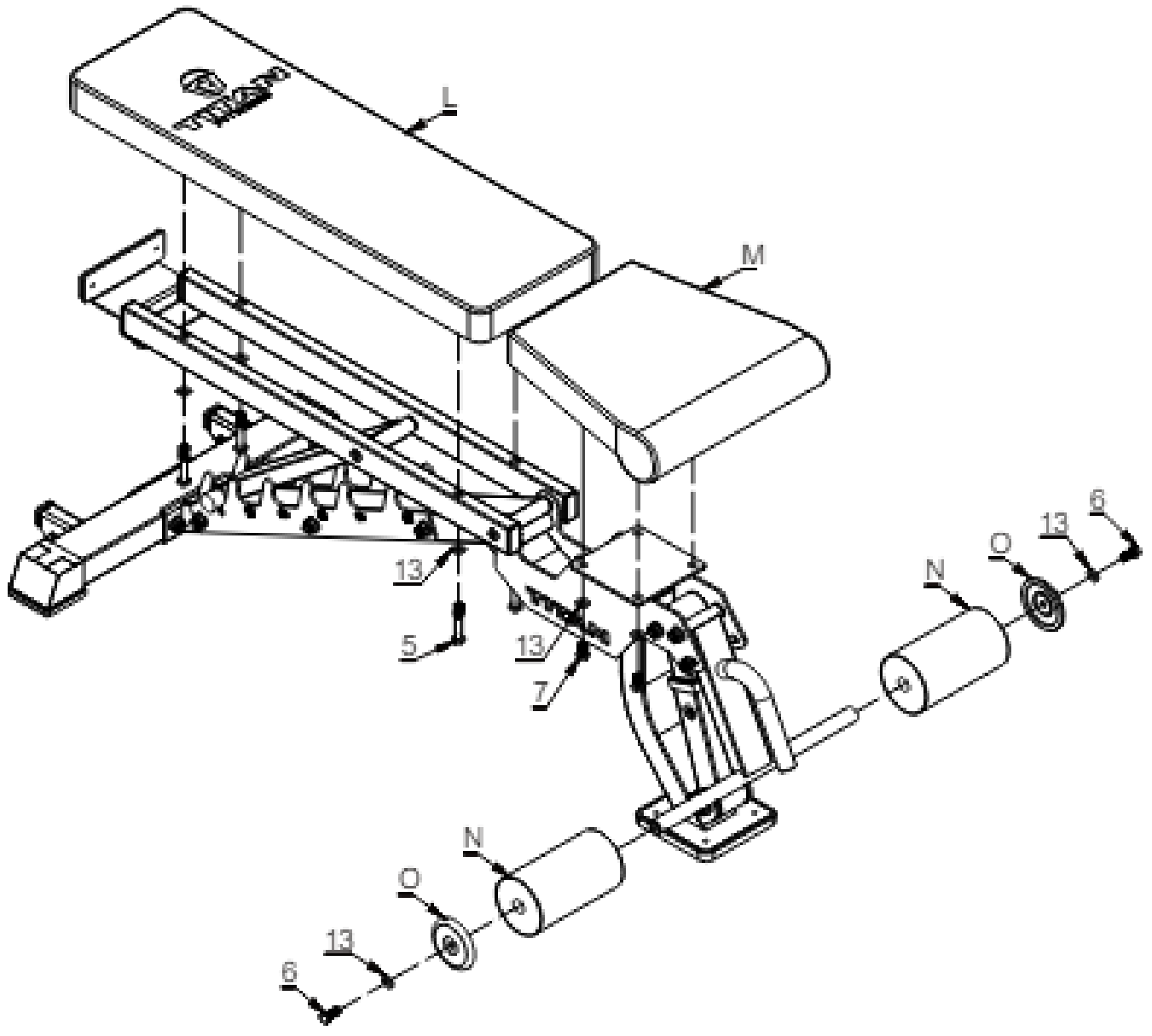

ACKNOWLEDGEMENT OF RISK AND RELEASE OF LIABILITY

The use of any equipment, including this one, involves the potential risk of injury. Apart from any warranty claim that might be presented for a claimed defect in material or workmanship of the product, you accept and assume full responsibility for any and all injuries, damages (both economic and non-economic), and losses of any type, which may occur, and you fully and forever release and discharge Titan, its insurers, employees, officers, directors, associates, and agents from any and all claims, demands, damages, rights of action, or causes of action, present or future, whether the same be known or unknown, anticipated, or unanticipated, resulting from or arising out of the use of said equipment.

This equipment must be used with care by capable and competent individuals under supervision,

WARNING



Heavy object. Use lifting aids and proper lifting techniques when moving.



Choking hazard. Small parts – Please exercise caution if small children or pets are present.



Sharp objects may be involved. Use precaution and protection.

TITAN LIMITED WARRANTY: TERMS, EXCLUSIONS AND LIMITATIONS OF REMEDIES

This product comes with a one (1) year limited warranty that can be found at www.titan.fitness/warranty.html Please review the same for all details regarding the Titan Limited Warranty.

THE TITAN LIMITED WARRANTY FOUND AT WWW.TITAN.FITNESS/WARRANTY IS EXCLUSIVE AND IS IN LIEU OF ALL OTHER WARRANTIES, EXPRESS OR IMPLIED, INCLUDING ANY IMPLIED WARRANTY OF MERCHANTABILITY AND/OR FITNESS FOR A PARTICULAR PURPOSE, EACH OF WHICH IS HEREBY DISCLAIMED.



NEED HELP? CONTACT US FIRST.

1-888-410-1503

info@titan.fitness

www.titan.fitness

© 2024 Titan Brands