

70" ADJUSTABLE SHELF FOR ELITE SERIES MASS STORAGE SYSTEM

401879 - ESTOR70RTSHLF



Operator's Manual

Read the Operator's Manual entirely. When you see this symbol, the subsequent instructions and warnings are serious follow without exception. Your life and the lives of others depend on it!

EXPLODED VIEW/ FULL PARTS LIST

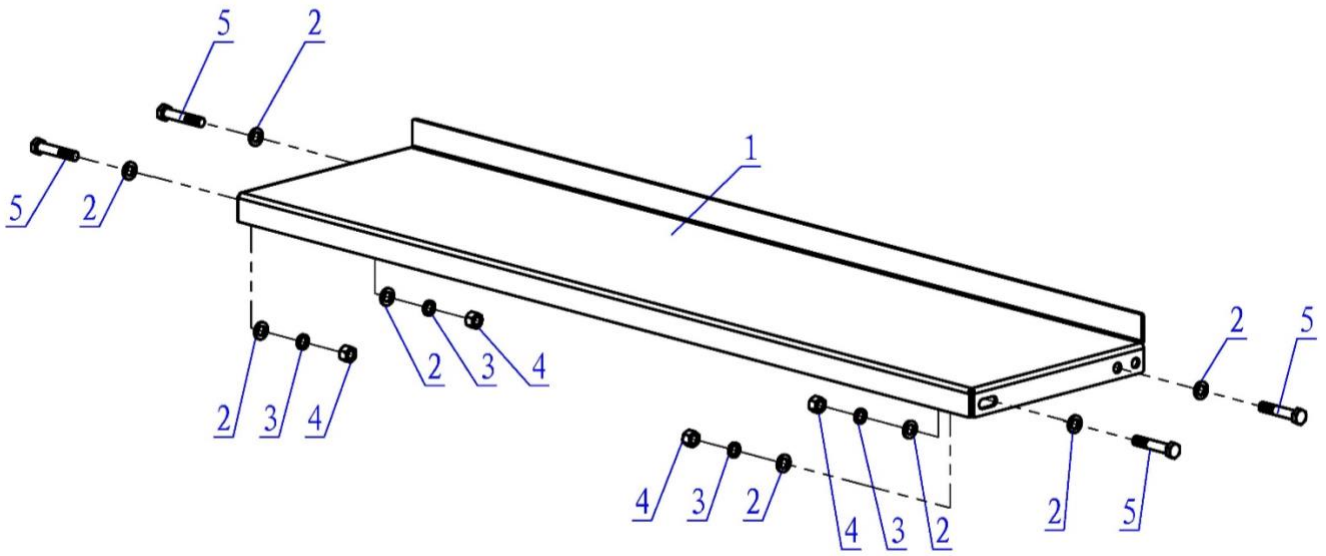

KEY	BOX	DESCRIPTION	QTY
1	1	70" DUMBBELL RACK	1
2	1	FLAT GASKET	8
3	1	SPRING WASHER	4
4	1	FLAT NUT	4
5	1	HEX BOLT	4

ASSEMBLY INSTRUCTIONS

ESTOR42RTSHLF and ESTOR70SHLF have 3 sets of bolt holes at each end. Depending on the holes used the shelf can be mounted:

- Flat with lip at back of shelf to keep items from falling off back of shelf
- 20 Degree Angle with lip at front of shelf to keep items on the shelf
- 30 Degree Angle with lip at front of shelf to keep items on the shelf



ACKNOWLEDGEMENT OF RISK AND RELEASE OF LIABILITY

The use of any equipment, including this one, involves the potential risk of injury. Apart from any warranty claim that might be presented for a claimed defect in material or workmanship of the product, you accept and assume full responsibility for any and all injuries, damages (both economic and non-economic), and losses of any type, which may occur, and you fully and forever release and discharge Titan, its insurers, employees, officers, directors, associates, and agents from any and all claims, demands, damages, rights of action, or causes of action, present or future, whether the same be known or unknown, anticipated, or unanticipated, resulting from or arising out of the use of said equipment.

This equipment must be used with care by capable and competent individuals under supervision,

WARNING



Heavy object. Use lifting aids and proper lifting techniques when moving.



Choking hazard. Small parts – Please exercise caution if small children or pets are present.



Sharp objects may be involved. Use precaution and protection.

TITAN LIMITED WARRANTY: TERMS, EXCLUSIONS AND LIMITATIONS OF REMEDIES

This product comes with a one (1) year limited warranty that can be found at www.titan.fitness/warranty.html Please review the same for all details regarding the Titan Limited Warranty.

THE TITAN LIMITED WARRANTY FOUND AT WWW.TITAN.FITNESS/WARRANTY IS EXCLUSIVE AND IS IN LIEU OF ALL OTHER WARRANTIES, EXPRESS OR IMPLIED, INCLUDING ANY IMPLIED WARRANTY OF MERCHANTABILITY AND/OR FITNESS FOR A PARTICULAR PURPOSE, EACH OF WHICH IS HEREBY DISCLAIMED.



NEED HELP? CONTACT US FIRST.

1-888-410-1503

info@titan.fitness

www.titan.fitness

© 2024 Titan Brands